



JUEGO DE PUNTAS SURTIDAS



B420

SET X 24 PCS.
CON EXTENSION PARAPUNTAS
TORX: T10-T15-T20-T25-T30
PHILLIPS: 1-2-3
PLANA: 4-6-7mm
PZ: 1-2-3
H2-2.5-3-4-5
S1-S2



PUNTAS Y TUBOS



B320

CON MANGO "T" ANATOMICO.
SET X 21 PCS.
TUBOS EN MILIMETROS:
4 - 5 - 6 - 7 - 8 - 9 - 10 - 11 - 13MM
P4 - P5 - P6 - P7
PH: 1 - 2 PZ: 1 - 2 T15 - T25
1 ADAPTADOR PARA TUBOS



TUBOS GRANDES SET X 40 PCS.



B475

EN CAJA PLÁSTICA
TUBOS: 9 - 10 - 11 - 12 - 13 - 14 - 17 - 19MM.
INCLUYE MANGO ACODADO DE 1/2"

PUNTAS Y TUBOS SURTIDOS SET X 37 PCS



B430

CON MANGO "T".
EN CAJA PLÁSTICA
PH: 1 - 2 X 2UN. - 3 X 2UN.
PZ: 1-2 X 2UN.
PLANA: 4 - 5 - 5.5 - 6MM.
TUBOS: 5 - 6 - 7 - 8 - 9 - 10 - 11 - 12 - 13MM.
ADAPTADOR FLEXIBLE.
EXTENSION PARA PUNTAS
EXTENSION - ADAPTADOR PARA TUBOS.

PUNTAS Y TUBOS SURTIDOS SET X 41 PCS



B440

CON MANGO SET X 41 PCS.
EN CAJA PLÁSTICA
TUBOS MILIMÉTRICOS: 6 - 7 - 8 - 9 - 10 - 11 - 12mm
TUBOS EN PULGADA: 3/16" - 1/4" - 5/16" - 11/32" - 3/8" - 7/16" - 1/2"
PUNTAS: T10 - T15 - T20 - T25 - T27 - T30 - T40
H 1.5- 2 - 2.5 - 3 - 4 - 5 - 5.5 - 6
P5 - P6 - P7
3/16" - 1/4" - 9/32"
PH1 - PH2 - PH3 - S1 - S2

TUBOS SURTIDOS SET X 25 PCS. (HASTA 22 MM)



B425

ENCASTRE 1/2"
MANGO BERBIQUI
EXTENSION 5"
LLAVE CRIQUE
TUBOS HEXAGONALES MILIMÉTRICOS:
8-9-10-12-13-14-15-16-17-18-19-20-21-22mm
TUBOS HEXAGONALES EN PULGADAS:
3/8" - 1/2" - 7/16" - 9/16" - 5/8"
TUBO SACABUJIA DE 21mm

TUBOS SURTIDOS SET X 25 PCS. (HASTA 32MM)



B426

ENCASTRE 1/2"
MANGO BERBIQUI
LLAVE CRIQUE
MANGO DESLIZANTE "T"
2 BARRAS DE EXTENSION
SACABUJIA 21mm
TUBOS: 10 - 11 - 12 - 14 - 16 - 17 - 18 - 19
20 - 21 - 22 - 23 - 24 - 27 - 30 - 32mm

TUBOS GRANDES SET X 21 PCS.



B480

MILIMETRICOS EN CAJA PLASTICA - ENCASTRE: 3/4"
LLAVE CRIQUE REVERSIBLE
MANGO DESLIZANTE "T"
BARRAS DE EXTENSION DE 100mm Y 200mm
TUBOS: 19-21-22-23-24-26-27-30-32-34-36-38-41-46-48-50mm

B481

PULGADAS EN CAJA PLÁSTICA - ENCASTRE: 3/4"
LLAVE CRIQUE REVERSIBLE
MANGO DESLIZANTE "T"
BARRAS DE EXTENSION DE 100mm Y 200mm
TUBOS PULGADAS: 7/8"-15/16"-1"-1 1/16"-1 1/8"-1 3/16"-1 1/4"-1 5/16" 1 3/8"-1 7/16"-1 1/2"-1 5/8"-1 3/4"-1 13/16"-1 7/8"-2"

TUBOS GRANDES SET X 40 PCS.



B450

TUBO SACABUJIA
MANGO 6"
LLAVE CRIQUE REVERSIBLE DE 3/8"
ADAPTADOR 1/4" X 3/8"
DISCO PLASTICO PARA GIRO MANUAL
12 TUBOS DE ENCASTRE DE 1/4" EN PULGADAS:
5/32-3/16-7/32-1/4-9/32-5/16-11/32-3/8-13/32-7/16-15/32-1/2"
12 TUBOS DE ENCASTRE DE 1/4" EN MM:
4-4,5-5-5,5-6-7-8-9-10-11-12-13 MM.
3 TUBOS DE ENCASTRE DE 3/8" EN MM: 14-16-17 MM.
3 TUBOS DE ENCASTRE DE 3/8 EN PULG.: 9/16-11/16-3/4"
EN CAJA PLÁSTICA.

TUBOS Y PUNTAS SURTIDOS SET X 52 PCS.



B476

2 LLAVES CRIQUE REVERSIBLES DE 3/8" Y 1/2"
TUBO SACABUJIA 21mm
DESTORNILLADOR ADAPTADOR DE 1/4"
EXTENSIÓN DE 70mm
ADAPTADOR PARA PUNTAS
DISCO PLASTICO DE GIRO MANUAL
PUNTAS PHILLIPS: PH1 - PH2 - PH3
PUNTAS PLANAS: 5 - 7mm
TUBOS HEXAGONALES PULGADAS ENC. 1/4":
5/32" - 3/16" - 7/32" - 1/4" - 9/32" - 11/32" - 5/16" - 13/32" - 3/8" - 7/16" - 15/32" - 1/2"
TUBOS HEXAGONALES MILIMETRICOS ENC. 1/4":
4 - 4,5 - 5 - 5,5 - 6 - 6,5 - 7 - 8 - 9 - 10 - 11 - 12 - 13mm
TUBOS HEXAGONALES MILIMETRICOS ENC. 1/2": 16 - 17 - 19 - 21mm
TUBOS HEXAGONALES MILIMETRICOS ENC. 3/8": 11 - 12 - 13mm
TUBOS HEXAGONALES ENC. 3/8": 7/16" - 1/2" - 9/16"
TUBO EXTENSIÓN ENC. 1/4": 1/4" - 5/16" - 3/8"

TUBOS Y PUNTAS SURTIDOS SET X 52 PCS.



B477

ENCASTRE 1/4" Y 1/2"
DESTORNILLADOR ADAPTADO
2 LLAVES CRIQUE 1/2" Y 1/4"
EXTENSION ARTICULADA 1/2"
EXTENSION 4.5" Y 10"
3 LLAVES ALLEN
TUBO SACABUJIA DE 21MM
MANGO DESLIZ. 1/4" Y 1/2" "T"
ADAPTADOR PARA PUNTAS
ADAPTADOR LARGO PARA TUBO DE 10 A 30MM
ADAPTADOR CORTO PARA TUBO DE 4 A 13MM
PUNTAS PLANAS: 3-4-5-6-7MM
PUNTAS PHILLIPS: 1-2-3
PUNTAS TORX: T10-T15-T20-T25-T30
TUBOS HEXAGONALES ENC. 1/4":
4 - 4,5" - 5 - 5,5 - 6 - 7 - 8 - 9 - 10 - 11 - 13MM
TUBOS HEXAGONALES ENC. 1/2":
10 - 11 - 12 - 13 - 14 - 15 - 16 - 17 - 19 - 22 - 24 - 27 - 30MM.

TUBOS GRANDES SET X 26 PCS.



B478

ENCASTRE 3/4 Y 1"
LLAVE CRIQUE
MANGO DESLIZANTE "T"
MANGO ACODADO
EXTENSION 20cm
ADAPTADOR
TUBOS HEXAGONALES MILIMETRICOS ENC. 3/4":
21 - 22 - 23 - 24 - 26 - 27 - 28 - 29 - 30 - 31 - 32 - 34 - 36
38 - 41 - 46 - 50mm
TUBOS HEXAGONALES MILIMETRICOS ENC. 1":
55 - 60 - 65mm



**LLAVES TORX
SET X 7 PCS.**

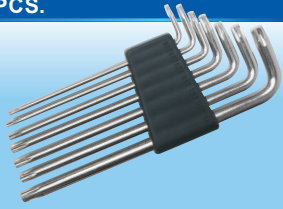

B520

EN BLISTER
T10 - T15 - T20 - T25 - T27 - T30 - T40

**LLAVES TORX
SET X 9 PCS.**



B436

180 MM.
T10 - T15 - T20 - T25 - T27 -
T30 - T40 - T45 - T50.

PESCA TORNILLO



O640

CON PINZA

O650

PUNTA IMANTADA

PINZA SACABOCADO MULTIPLE



B250

**LLAVE CRIQUE CON MANGO
DE GOMA**



1/4" **B489**
3/8" **B490**
1/2" **B491**

**LLAVE AJUSTABLE
FOSFATIZADA**



B500

CALIDAD SUPERIOR 6"

**DESTORNILLADOR
BUSCAPOLO**



CHICO.
PRUEBA CORRIENTE DE 100 A 250V.

NA9078

NA9077

REFORZADO
PRUEBA CORRIENTE DE 150 A 250V.

PINZAS DE BRUSELAS



B045

SET X 4 PCS.
IDEAL PARA TAREAS FINAS

SACABOCADO DE GOLPE

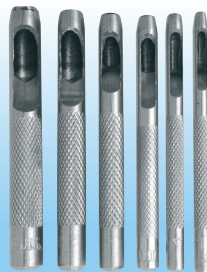

B260

SET X 6 PCS.
3 - 4 - 5 - 6 - 7 - 8 MM

TIJERA CORTA CHAPA



L010

LLAVE PARA CAÑO



APERTURA DE BOCA:
1" - 1 1/2" - 2"

TIPO BAHCO

140 **B209**
141 **B210**
142 **B211**

ALICATE CORTE OBLICUO



MANGO ROJO

6" **B070**
8" **B072**

ALICATES MINI



B040

PARA ELECTRÓNICA
SET X 5 PCS.

PINZA DE FUERZA REGULABLE



B230

DE PUNTA
TAMAÑO 9"

PINZA DE FUERZA REGULABLE



B233

BOCA ANCHA
TAMAÑO 11"

PINZA DE FUERZA REGULABLE



B220

TAMAÑO 10"

PINZA DE FUERZA REGULABLE



B231

BOCA "C"
TAMAÑO 10"

PINZA DE FUERZA REGULABLE



B232

BOCA "W"
TAMAÑO 10"

BARRENITOS



1060

SET X 4 PCS.



TARUGO VX



NUEVO

6 MM X 1000 **NA8676**
8 MM X 500 **NA8677**
10 MM X 250 **NA8678**
12 MM X 250 **NA8679**

TARUGO STANDARD



5 MM X 1000 **NA8418**
6 MM X 1000 **NA8419**
8 MM X 1000 **NA8420**
10 MM X 500 **NA8421**
12 MM X 250 **NA8422**

TARUGO STANDARD CON TOPE



5 MM X 1000 **NA8423**
6 MM X 1000 **NA8424**
8 MM X 1000 **NA8425**
10 MM X 500 **NA8426**

TARUGO UNIVERSAL

IND. ARG.



6 MM X 1000 **NA8427**
8 MM X 500 **NA8428**
10 MM X 250 **NA8429**

TARUGO UNIVERSAL CON TOPE

IND. ARG.



6 MM X 1000 **NA8430**
8 MM X 500 **NA8431**
10 MM X 250 **NA8432**

TARUGO PARA YESO

IND. ARG.



6 MM X 1000 **NA8433**
8 MM X 500 **NA8434**

TARUGO CLAVO CANAL

IND. ARG.

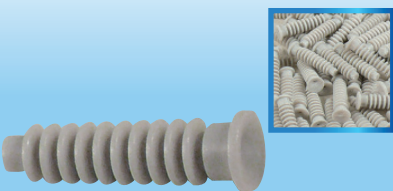

NA8435
X 2000 UNIDADES

CINTA METÁLICA PERFORADA

IND. ARG.



NA8490
ANCHO DE CINTA 17MM
PERFORACIONES DE 5 Y 7.5MM

CINTA METÁLICA GALVANIZADA, CON ORIFICIOS TROQUELADOS

PARA INSTALACIÓN SIMPLE, SOPORTE DE TUBERÍAS Y CONDUCTOS EN GENERAL. UN RÁPIDO Y ECONÓMICO SISTEMA DE FIJACIÓN.

30 MTS.





// RIBOT

REMACHES RÁPIDOS DE ALUMINIO INDUSTRIA ARGENTINA



3,5 MM

6 X1000PCS	NA8201
8 X1000PCS	NA8202
10 X1000PCS	NA8203
12 X1000PCS	NA8204
14 X1000PCS	NA8205
16 X1000PCS	NA8206
19 X1000PCS	NA8207
24 X1000PCS	NA8208
30 X500PCS	NA8209

4 MM

6 X1000PCS	NA8210
8 X1000PCS	NA8211
10 X1000PCS	NA8212
12 X1000PCS	NA8213
14 X1000PCS	NA8214
16 X1000PCS	NA8215
19 X1000PCS	NA8216
24 X1000PCS	NA8217
30 X500PCS	NA8218

5 MM

8 X 500PCS	NA8219
10 X 500PCS	NA8220
12 X 500PCS	NA8221
14 X 500PCS	NA8222
16 X 500PCS	NA8223
20 X 500PCS	NA8224
24 X 500PCS	NA8225
28 X 500PCS	NA8226
30 X 500PCS	NA8227

ABRAZADERAS

INDUSTRIA ARGENTINA



MINI 7 MM - PACK X 100 UN.

8-12 MM	NA8020
10-16 MM	NA8021
12-22 MM	NA8022



TUERCA Y TORNILLO - PACK X 100 UN.

8-10 MM	NA8016
10-12 MM	NA8017
12-14 MM	NA8018
14-16 MM	NA8019



ESTANDAR 9 MM - PACK X 100 UN.

8-16 MM	NA8001
12-22 MM	NA8002
16-27 MM	NA8003
23-35 MM	NA8004
30-45 MM	NA8005
32-50 MM	NA8006
40-60 MM	NA8007
50-70 MM	NA8008



REFORZADA 12 MM - PACK X 100 UN.

12-22 MM	NA8009
16-27 MM	NA8010
23-35 MM	NA8011
30-45 MM	NA8012
32-50 MM	NA8013
40-60 MM	NA8014
50-70 MM	NA8015



TORNILLOS

INDUSTRIA ARGENTINA

PERFECTO 



DRY WAFER

PUNTA MECHA

APLICACIÓN: UTILIZADO PARA UNIÓN DE PLACAS DE MADERA, AGLOMERADO O CHAPA CON PERFILES METÁLICOS.

ART. N°

T0502	T1 8X1/2" X 500
T0503	T1 8X9/16" X 500
T0504	T1 8X3/4" X 500
T0506	T1 8X1" X 300



DRY WAFER

PUNTA AGUJA

APLICACIÓN: UTILIZADO PARA MADERA, CHAPA CON PERFILES METÁLICOS DE BAJO O MEDIANO CALIBRE, COMO EL MONTAJE DE PERFILERÍA, CIELORRASOS METÁLICOS, CONSTRUCCIONES MODULARES, CARPINTERÍA METÁLICA, CARTELERÍA PUBLICITARIA, CARROCIERÍAS, DUCTOS DE VENTILACIÓN, ZINGUERÍA, ETC.

ART. N°

T0202	T1 8X1/2" X 500
T0203	T1 8X9/16" X 500
T0204	T1 8X3/4" X 500
T0206	T2 8X1" X 300



DRY TROMPETA

PUNTA AGUJA

APLICACIÓN: UTILIZADO PARA UNIÓN DE PLACAS DE YESO, MADERA, AGLOMERADO O CHAPA CON PERFILES METÁLICOS DE BAJO O MEDIANO CALIBRE, COMO EL MONTAJE DE PLACAS DE YESO O MULTILAMINADO A PERFILERÍA, CIELORRASOS METÁLICOS, CONSTRUCCIONES MODULARES, CARPINTERÍA METÁLICA, CARTELERÍA PUBLICITARIA, CARROCIERÍAS, DUCTOS DE VENTILACIÓN, ZINGUERÍA, ETC.

ART. N°

T0106	T2 6X1" X 500
T0107	T2 6X1"1/8 X 500
T0109	T3 6X1"1/2 X 500
T0112	T4 6X2" X 300



HEXAGONAL

PUNTA MECHA PARA TECHO CON ARANDELA CHAPA VULANIZADA

APLICACIÓN: FIJACIÓN DE CHAPAS PARA EL MONTAJE SOBRE ESTRUCTURAS COMO TECHOS Y PAREDES, TINGLADOS, GALPONES, CARPINTERÍA METÁLICA, CASAS PREFABRICADAS, SILOS, ETC.

ART. N°

T0306	T2 14X1" X 200
T0309	T2 14X1"1/2 X 200
T0312	T2 14X2" X 200
T0313	T2 14X2" 1/2 X 250
T0314	T2 14X3" X 250



DRY TROMPETA

PUNTA MECHA

APLICACIÓN: UTILIZADO PARA UNIÓN DE PLACAS DE MADERA, AGLOMERADO O CHAPA CON PERFILES METÁLICOS.

ART. N°

T0607	T2 6X1"1/8 X 500
T0610	T3 6X1"5/8 X 500



HEXAGONAL

PUNTA AGUJA ATERRAJANTE CON ARANDELA CHAPA VULANIZADA

APLICACIÓN: FIJACIÓN DE CHAPAS PARA EL MONTAJE SOBRE ESTRUCTURAS DE MADERA SIN PERFORADO PREVIO COMO TIRANTES, CARPINTERÍA, CASAS PREFABRICADAS, ETC.

ART. N°

T0417	T2 14X2" X 200
T0418	T2 14X2"1/2 X 250
T0419	T2 14X3" X 250



FIX MADERA NEGRO

APLICACIÓN: UTILIZADO PARA MADERAS BLANDAS, AGLOMERADOS, CARPINTERÍA EN GENERAL.

ART. N°

T0905/1	8 X 3/4" X 500
T0906/1	8 X 1" X 500
T0908/1	8 X 1"1/4 X 500
T0909/1	8 X 1"1/2 X 500
T0911/1	8 X 1"3/4 X 300
T0912/1	8 X 2" X 300
T1005/1	6 X 3/4" X 500
T1006/1	6 X 1" X 500
T1008/1	6 X 1"1/4 X 500
T1009/1	6 X 1"1/2 X 500
T1011/1	6 X 1"3/4 X 500
T1012/1	6 X 2" X 300



CUTTER ECONÓMICO



O205
ANCHO 9MM

CUTTER ECONÓMICO



O210
ANCHO 18MM

CUTTER REFORZADO PROFESIONAL



O220
INTERIOR METÁLICO
ANCHO 18 MM

RASPÍN MULTIUSO



O235

PINZA DE SUCCIÓN SIMPLE



R450
SACABOLLOS

PINZA DE SUCCIÓN DOBLE



R451
SACABOLLOS

CORTAVIDRIO



O250
PUNTADEDIAMANTE

CORTAVIDRIO CON 6 RUEDAS GIRATORIAS



O270

CORTAVIDRIO CON ACEITE



O260
ACRILICOTRANSARENTE

PINZA MASA PARA SOLDADORA

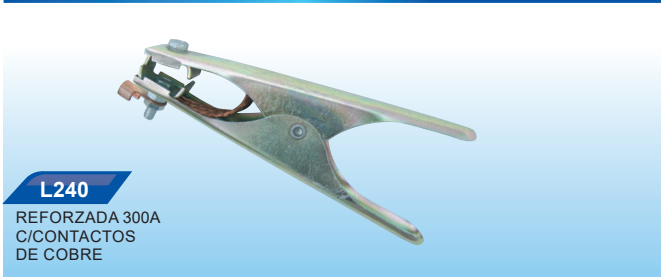

L240
REFORZADA 300A
C/CONTACTOS
DE COBRE

PINZA PORTA ELECTRODO



L230
REFORZADA 500A

SOLDADOR ZINGUERO



3 KG NA5085
10 KG NA5086

SOLDADOR TECHISTA



3 KG NA5081
10 KG NA5082

SOLDADOR PLOMERO



3 KG NA5083
10 KG NA5084

SOLDADOR PARA GAS BUTANO



NA5079

SOLDADOR PARA GAS BUTANO



NA5080

ENCENDIDO ELECTRÓNICO

SOPLETE PARA SOLDAR

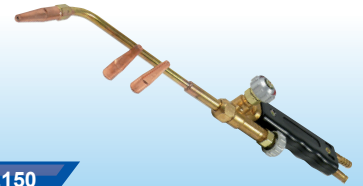

L150

CON LUZ AUTÓGENA
3 PICOS INTERCAMBIABLES

SOLDADOR LÁPIZ



CON PUNTA DE CERÁMICA
USO ELECTRÓNICO
220-240V 50 HZ CLASE I

40W NA7477
60W NA7478

SOPORTE PARA SOLDADOR LÁPIZ

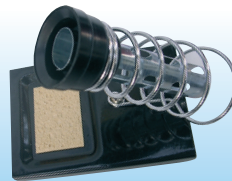

T910

CHISPERO ENCENDEDOR

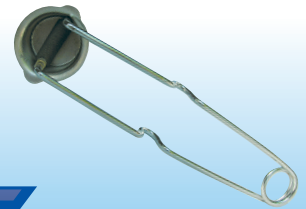

L140

PARA SOPLETES

MARTILLO BOLITA



MANGO DE MADERA

100G G009
150G G099
200G G010

MARTILLO DE GOMA



MANGO DE MADERA

12 OZ G015
16 OZ G016

MAZA DE ALBAÑIL



IND. ARG.

MANGO DE MADERA

500G NA1092
750G NA1093
1000G NA1094
1250G NA1095
1500G NA1096
2000G NA1097

MARTILLO GALPONERO



G030

MANGO DE MADERA
16 OZ

HACHUELA



G100

MANGO DE MADERA

PUNTA HEXAGONAL



F210

CON PROTECTOR DE GOMA
300 MM

CORTA HIERRO



F209

CON PROTECTOR DE GOMA
300MM

PUNTA DE ALBAÑIL

IND. ARG.



NA5230

3/4"
300 MM

CORTA HIERRO 3/4"

IND. ARG.



ACERO FORJADO

250MM NA1003
300MM NA1004
350MM NA1005
400MM NA1006

CLAVO PARA ALBAÑIL

IND. ARG.



15 CM NA8388
20 CM NA8389
25 CM NA8390

CLAVO PARA ALBAÑIL



F215



GUBIAS REFORZADAS



I080

MANGO DE MADERA
SET X 6 PCS.
TAMAÑO: 7"

FORMONES



I100

MANGO DE MADERA
SET X 4 PCS.
6, 12, 18, 24 MM

ESCOFINAS



I090

MANGO DE MADERA
SET X 3 PCS
MEDIA CAÑA, PLANA,
REDONDA.
TAMAÑO 8"

LIMAS PARA MATRICERO



K070

MANGO PLÁSTICO
SET X 6 PCS.
LIMAS EN PUNTA:
TRIANGULAR,
1/2 CAÑA, CUADRADA,
REDONDA Y PLANA.
LIMASIN PUNTA: PLANA.

LIMAS PARA METAL



K050

TAMAÑO 8" - SET X 3 PCS.
MEDIA CAÑA, PLANA
PARALELA, REDONDA.
CON MANGO DE MADERA

LIMA PARA METAL 8"



MEDIA CAÑA **K010**
REDONDA **K020**
TRIÁNGULO **K030**
PLANA **K040**

TALADRO DE MANO



J730

TAMAÑO: 12"
Ø MECHA MÁXIMO: 10 MM

LLAVE PARA MANDRIL



J660

4 EN 1

BONETE DE LANA



INCLUYE TIRANTES
Ø115 MM **NA8341**
Ø180 MM **NA8046**

MECHA RADIAL

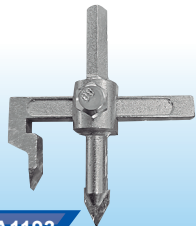

NA1193

100 MM

MECHAS PARA MADERA



J330

LARGO 300 MM
SET X 7 PCS.
4-5-6-7-8-10-12 MM

MECHAS COPA PARA MADERA



PROFUNDIDAD 1" **J645**
PROFUNDIDAD 2" **J640**

SET X 7 PCS
Ø: 26, 32, 38, 45, 50, 56, 63 MM

AFILADOR DE MECHAS



J670

C/PIEDRA DE
REPUESTO

BLACK JACK

MECHAS DE WIDIA



IND. ARG.



CON PUNTA
ALEMANA
5X85MM **NA1098**
6X100MM **NA1099**
8X120MM **NA1100**
10X120MM **NA1101**
12X120MM **NA1102**

MECHAS PARA MADERA



J010

SET X 5 PCS.
MEDIDAS: 4-5-6-8-10 MM

MECHAS PARA MADERA



J030

PARA MADERA
SET X 6 PCS.
10-12-16-18-20-25 MM

CEPILLO COPA DE BRONCE



PARA TALADRO
19 MM **J788**
24 MM **J789**

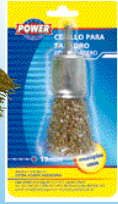

CEPILLO COPA DE BRONCE



PARA TALADRO
65 MM **J784**
75 MM **J785**



CEPILLOS DE BRONCE



J775

PARA TALADRO
3 PCS: 2 COPA +
1 PLANO



CEPILLOS DE BRONCE



J770

PARA TALADRO
SET X 8 PCS.
Ø: 75-65-50-40-25MM
3 ADAPTADORES

CEPILLO CIRCULAR DE ACERO TRENZADO



PARA AMOLADORA
4" **J765**
5" **J766**
6" **J767**

CEPILLO DE ACERO TRENZADO



J787

PARA TALADRO
TAMAÑO: 75MM



CEPILLO DE ACERO TRENZADO



PARA AMOLADORA
Ø 3" **J819**
Ø 4" **J820**



CEPILLO DE BRONCE



PARA AMOLADORA
Ø 3" **J779**
Ø 4" **J780**



CEPILLO CÓNICO DE BRONCE



J781

Ø: 4" - PARA AMOLADORA



CEPILLO CIRCULAR



RIZADO DE ACERO
4" **NA1142**
5" **NA1143**
6" **NA1144**
7" **NA1145**
8" **NA1146**

ESCOFINAS MONTADAS PARA TALADRO



J015

SET X 5 PCS.



PIEDRAS MONTADAS



DE DESBASTE PARA TALADRO
SET X 5 PCS.
CHICAS **J425**
GRANDE **J420**



DISCO DE GOMA



J300

CON ADAPTADOR PARA TALADRO
125MM - FLEXIBLE PARA LIJAR

DISCO DE GOMA

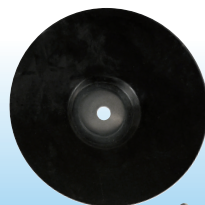

NA1157

115MM
CON ADAPTADOR PARA TALADRO



ESCOFINA PARA DESBASTE

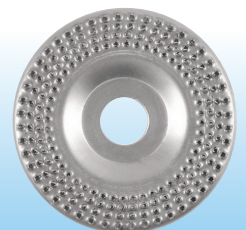

NA8331

115 MM CENTRO DEPRIMIDO



SIERRA DE MADERA



PARA AMOLADORA CON CENTRO DEPRIMIDO
115 MM 96 DIENTES
175 MM 80 DIENTES

NA8103
NA8330

RESPALDO LIJA



NA1156

115 MM
PARA LIJAS CON VELCRO

DISCO FLAP



DIAMETRO 115 MM
ROSCA M14

GRANO DE LIJA 60 **J315**
GRANO DE LIJA 80 **J3151**

DISCO CARBURO DE SILICIO



115 X 3 MM **J616**
115 X 6 MM **J617**
180 X 6 MM **J619**

DISCO ÓXIDO DE ALUMINIO



115 X 3 MM **J601**
115 X 6 MM **J610**

DISCOS DE CORTE PARA AMOLADORA



115 X 2 MM **J600**
180 X 3 MM **J602**
115 X 1 MM **J605**

DISCO CARBURO DE SILICIO



J614

115 X 1.6 MM

ARCO DE SIERRA JUNIOR



C020

MANGO DE PLÁSTICO REFORZADO CON HOJA INCLUIDA.

ARCO DE SIERRA JUNIOR



C021

MANGO PLÁSTICO CON 5 HOJAS DE SIERRA DE REPUESTO.

ARCO PARA CALAR



C030

TAMAÑO 5" CON 4 HOJAS DE SIERRA DE REPUESTO

ARCO DE SIERRA PLANO

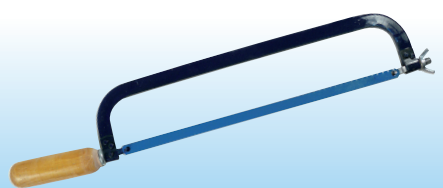

C041

CON HOJA 300 MM INCLUIDA.

ARCO DE SIERRA CROMADO



C010

AJUSTABLE DE 8-12" CON HOJA INCLUIDA.

ARCO DE SIERRA DE CAÑO



C040

MANGO NARANJA CON HOJA 300 MM INCLUIDA.

ARCO DE TRONZAR

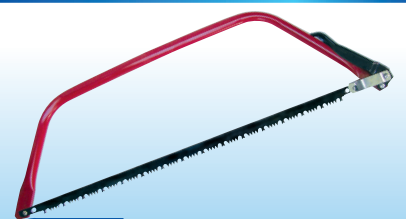

N290

TAMAÑO 24"

SERRUCHO DE PUNTA RECTA



C070

MANGO DE MADERA

SERRUCHO CARPINTERO



MANGO PLÁSTICO Y GOMA

16" **C090**

18" **C091**

20" **C092**

CORTADORA ANGULAR

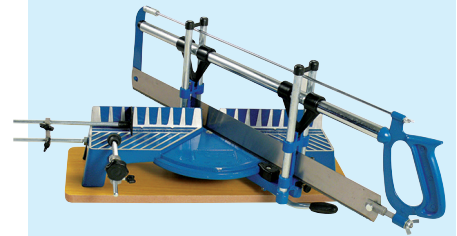

A280

CON ANGULOS REGULABLES
TAMAÑO DE LA HOJA: 550 MM

SERRUCHO CURVO ZAPALLERO



N285

12" MANGO DE MADERA

INGLETE CON SERRUCHO

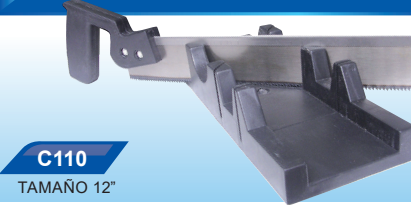

C110

TAMAÑO 12"

MORSA PARA CAÑOS



C170

CON TRIPODE
TAMAÑOS: 10-89 MM

BANCO DE TRABAJO



A220

REGULABLE. 75 CM ALTO,
60 CM LARGO, 33 CM ANCHO

DOBLADORA DE CAÑOS HIDRÁULICA



A260

CAP. MAX. DE DOBLADO: 16 TN.
HASTA 3" CON ACCESORIOS
ANGULO ROTACION: 0-110° BASE 360°
MEDIDAS ACCESORIOS: 1/2"/15 MM,
3/4"/20 MM, 1"/25 MM, 1 1/4"/32 MM,
1 1/2"/40 MM, 2 1/2"/65 MM, 3"/80 MM.

MORSA PLANA



C230

PARA TALADRO
TAMAÑO: 4"

PRENSAS MINI



C130

SET X 3 PCS.
TAMAÑO: 1" - 2" - 3"

DOBLADORA DE CAÑOS



L120

TAMAÑO: 16 MM

PESTAÑADORA PARA CAÑOS



L070

MORSA PARA CAÑOS

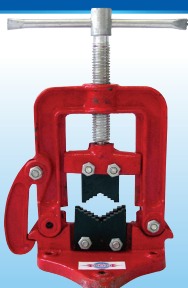

C220

TAMAÑOS: 10-65 MM

MORSA DE BANCO GIRATORIA

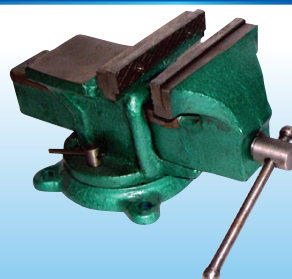

CON YUNQUE

3" **C180**

4" **C190**

5" **C200**

6" **C210**

MORSA MINI



C245

METÁLICA
TAMAÑO: 2"

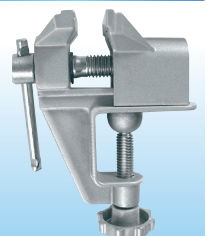



SARGENTO CARPINTERO



- 80 X 300 MM **C160**
- 80 X 400 MM **C161**
- 80 X 500 MM **C162**
- 120 X 800 MM **C163**
- 120 X 1200 MM **C164**

TERRAJAS Y MACHOS

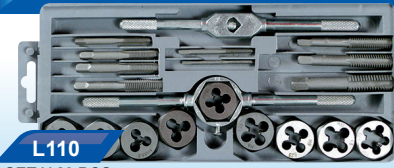

L110
 SET X 20 PCS.
 TERRAJAS: M3 X 0.5, M4 X 0.7, M5 X 0.8, M6 X 1.0, M7 X 1.0, M8 X 1.25, M9 X 1.25, M10 X 1.5, M12 X 1.75 / MACHOS: M8 X 1.25, M7 X 1.0, M6 X 1.0, M5 X 0.8, M3 X 0.5, M4 X 0.7, M12 X 1.75, M10 X 1.5, M9 X 1.25.
 1 PORTATERRAJA / 1 PORTAMACHO

TERRAJA PARA CAÑOS



L310
 MEDIDAS: 1/2" - 3/4" - 1"
 CON VALIJA PLASTICA

CALIBRE METÁLICO



D050
 TAMAÑO: 150 MM

METROS DE MADERA



TAMAÑOS
 1 M **NA1103**
 2 M **NA1104**

ESCUADRA CORTANTE



O290
 PARA EMPAPELADOR
 CON ESCALA MILIMÉTRICA

ESCUADRA TRIÁNGULO

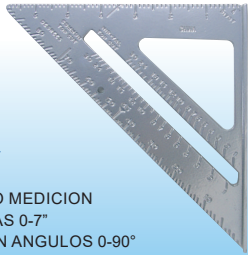

D110
 DE ALUMINIO MEDICION
 EN PULGADAS 0-7"
 MEDICION EN ANGULOS 0-90°

ESCUADRA DE ACERO

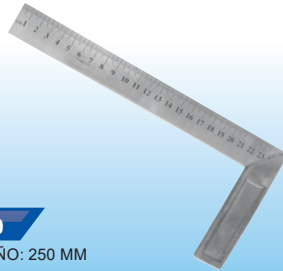

D070
 TAMAÑO: 250 MM

ESCUADRA ALBAÑIL

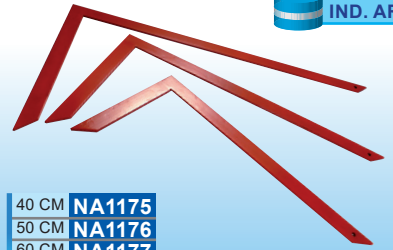

IND. ARG.

40 CM **NA1175**
 50 CM **NA1176**
 60 CM **NA1177**

ESCUADRA PARA SOLDAR



C150
 CON PRENSAS

NIVEL DE ALUMINIO



CON TOPES PLÁSTICOS
 300 MM **D170**
 400 MM **D171**
 500 MM **D172**
 800 MM **D173**

NIVEL DE ALUMINIO REFORZADO



CON TOPES PLÁSTICOS
 Y ESCALA MÉTRICA
 300 MM **D190**
 400 MM **D191**
 500 MM **D192**

NIVEL PROFESIONAL CORSIN

IND. ARG.

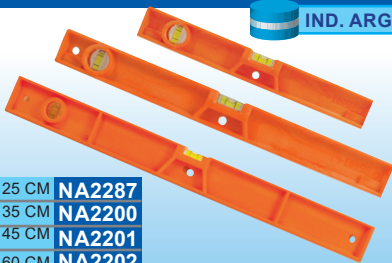

25 CM **NA2287**
 35 CM **NA2200**
 45 CM **NA2201**
 60 CM **NA2202**

MANGUERA NIVEL



TAMAÑOS
 15 M **D400**
 20 M **D401**

MARCADOR DE POLVO



D260
 30 M

**CEPILLOS MINI
MULTIUSO**



J850

SET X 3 PCS.

CEPILLOS SURTIDOS



SET X 3 PCS
CHICO 7" **J830**
GRANDE 9" **J831**

CEPILLO DE ACERO



NA1002

CON MANGO
TAMAÑO: 4 X 19

CEPILLO DE ACERO ANCHO

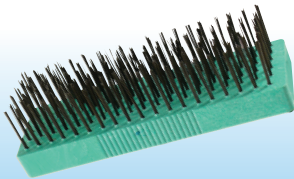

NA1001

TAMAÑO: 6 X 19

TANZA DE ALBAÑIL



NA8311

100 M DE Ø 0.8 MM

TANZA DE ALBAÑIL



X 100 M
PACK X 10 UNIDADES
0.30 MM **S740**
0.40 MM **S741**
0.50 MM **S742**

CARRETILLA DE ALBAÑIL

IND. ARG.



NA8072

60 LITROS
ECONÓMICA

**CARRETILLA DE ALBAÑIL
REFORZADA**

IND. ARG.



NA8071

60 LITROS
RUEDA DE GOMA
MACIZA

HORMIGONERA

IND. ARG.



NA7146

CON MOTOR-CAP. DE TACHO 130 L
NACIONAL CON GARANTÍA

**HORMIGONERA MONTADA
SOBRE RULEMANES**

IND. ARG.



NA7145

TACHO REFORZADO-CAP. DE TACHO 130 L
NACIONAL CON GARANTÍA

**LÁPIZ CARPINTERO
COMET**



NA1139

18 CM

NA1140

24 CM

**LÁPIZ ALBAÑIL
COMET**



NA1141

18 CM

NA1161

24 CM

**BALDE DE ALBAÑIL
REFORZADO**



NA8347

MANIJA INYECTADA
PACK X 12 UNIDADES



REPUESTO PARA CORTACERÁMICA



F145
15 X 6 X 1.5 MM

CORTANTE CIRCULAR



F146
PARA CORTACERÁMICA

NIVELADORES PARA PORCELANATO



NA1187
TORNILLO
125 UNIDADES

NA1188
TUERCA
40 UNIDADES

NIVELADORES PARA PORCELANATO

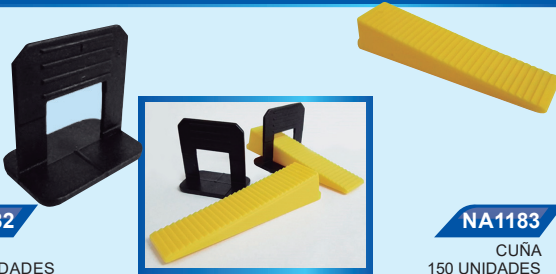

NA1182
ARCO
150 UNIDADES

NA1183
CUÑA
150 UNIDADES

SEPARADORES DE CERÁMICOS



2MM x 250 PCS. **F160**
3MM x 250 PCS. **F161**
4MM x 250 PCS. **F162**
5MM x 100 PCS. **F163**
6MM x 75 PCS. **F164**

PINZA CORTA CERÁMICA



F170

HACHA CON CABO



NA6128
5 LBS 91 CM

PICO ALBAÑIL PUNTA PALA



NA1173

PICO ALBAÑIL PUNTA PALA CON CABO



NA1174

PALA POCERA C/CORTO



NA1189

PALA ESTAMPADA TEMPLADA



NUEVO

MANGO PLÁSTICO
HECHA EN UNA SOLA PIEZA
PALA ANCHA **NA1190**
PALA DE PUNTA **NA1191**

CABO DE MADERA PARA PALA



IND. ARG.

LARGO 700 MM
MANGO PLÁSTICO **NA8053**
MANGO METÁLICO **NA8054**

PALA CORAZÓN

IND. ARG.



NA1154
MANGO PLÁSTICO
HECHA EN UNA SOLA PIEZA

PALA ANCHA Y DE PUNTA

IND. ARG.



MANGO PLÁSTICO
HECHA EN UNA SOLA PIEZA
PALA ANCHA **NA1105**
PALA DE PUNTA **NA1106**

PALAS SOLDADAS

IND. ARG.



PALAS DE CHAPA,
ACERO, ESTAMPADA
CABO METÁLICO DE CAÑO
PALA ANCHA **NA1180**
PALA DE PUNTA **NA1181**

LLANA YESERO LISA

IND. ARG.



FLEXIBLE

NA1153

125 X 300 MM



LLANA ALBAÑIL LISA

IND. ARG.



NA1148

125 X 300 MM

LLANA DENTADA

IND. ARG.



125 X 300 MM

DIENTES 6X6 **NA1149**

DIENTES 8X8 **NA1150**

DIENTES 10X10 **NA1151**

DIENTES 12X12 **NA1152**

CUCHARINES DE ARTISTA



Q475

SET X 5 PCS.

ESPÁTULAS PLÁSTICAS



F120

SET X 4 PCS.
ANCHO: 5 - 7,5 - 10 - 12 CM

ESPÁTULAS METALICÁS



F120

SET X 4 PCS.
ANCHO: 5 - 8 - 10 - 12 CM

ESPÁTULA



DE PINTOR

5 CM **NA1129**

6 CM **NA1130**

7 CM **NA1131**

8 CM **NA1132**

9 CM **NA1133**

DE ENDUIR

10 CM **NA1134**

12 CM **NA1135**

15 CM **NA1136**

17 CM **NA1137**

ESPÁTULA DE ACERO REFORZADA



MANGO DE MADERA

2" **F055**

3" **F056**

4" **F057**

ESPÁTULA PARA ENDUIR



MANGO DE MADERA

150 MM **F300**

170 MM **F301**

200 MM **F302**

NUMEROS PARA MARCAR



K080

TAMAÑO: 6 MM
DEL 0 AL 9

LETRAS PARA MARCAR



K090

TAMAÑO: 6 MM
DE LA "A" A LA "Z"

BANDAS DE LIJA PARA LIJADORA



O325

SET X 5 PCS.
MEDIDAS: 76 x 533 MM

PAPEL DE LIJA



N° 0 **O300-1**

N° 1 **O301-1**

N° 1 ½ **O302-1**

N° 2 **O303-1**

LIJA AL AGUA

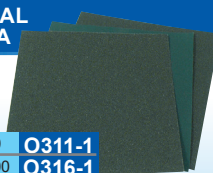

GRANO 80 **O311-1**

GRANO 400 **O316-1**

LIJA TELA ESMERIL

N° 1 **O320-1**

N° 3 **O322-1**

BASE PARA LIJAR



CON DISEÑO ANATÓMICO

165 x 85 MM **O281**

210 x 105 MM **O280**

ESTOPA

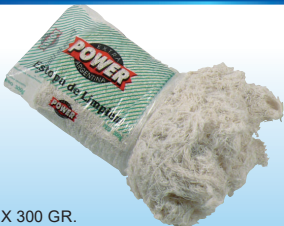

X 300 GR.

DE LIMPIEZA **NA8109**

DE LUSTRE **NA8108**

VIRUTA



X 250 GR.

FINA **NA8270**

MEDIANA **NA8271**

GRUESA **NA8272**

COBERTOR PLÁSTICO MULTIUSO



3 X 3 M **NA8366**

3 X 4 M **NA8367**

3 X 5 M **NA8368**

LONA PLÁSTICA MULTIUSO

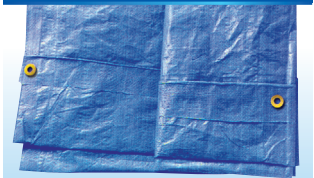

CON ARANDELAS METÁLICAS

2 x 3 M **O330**

3 x 4 M **O331**

4 x 6 M **O332**



FRATACHO PLÁSTICO

IND. ARG.



CON ESPUMA
20 CM **NA1078**
25 CM **NA1079**
30 CM **NA1080**

FRATACHO PLÁSTICO P/GRUESO

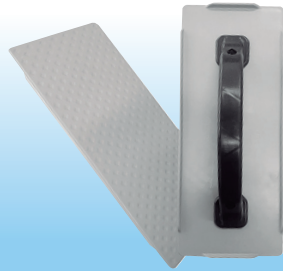

NA1186
30 CM

FRATACHO CON ABRASIVO MEDIANO



NA1147
13 X 20 CM
CAJA X 6 UNIDADES

ABRE TAPA LATA PINTURA



NA8448

PINCELES DE CERDA NEGRA



O460
SET X 4 PCS.
1/2" - 1" - 1 1/2" - 2"

PINCEL DE CERDA BLANCA



1" **O440**
1 1/2" **O441**
2" **O442**
3" **O443**

PINCEL DE CERDA BLANCA



Nº7 3/4" **NA8376**
Nº10 1" **NA8377**
Nº15 1 1/2" **NA8378**
Nº20 2" **NA8379**
Nº25 2 1/2" **NA8380**
Nº30 3" **NA8381**

PINCELETA



NA8179
ANCHO 4"

BANDEJA DE PINTOR CON REJILLA

IND. ARG.



NA8509
PLÁSTICA

RODILLO DE POLIESTER

IND. ARG.



5 CM **NA8231**
8 CM **NA8232**
11 CM **NA8233**

RODILLO DE POLIESTER

IND. ARG.

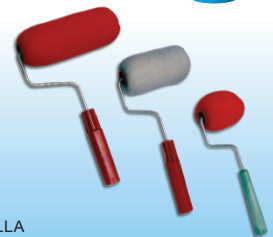

CON MALLA
5 CM **NA8234**
8 CM **NA8235**
11 CM **NA8236**

RODILLO DE POLIESTER

IND. ARG.



10 CM **NA8228**
17 CM **NA8229**
22 CM **NA8230**

RODILLO DE LANA SINTÉTICA

IND. ARG.



17 CM **NA8237**
22 CM **NA8238**

RODILLO DE LANA ESPECIAL

IND. ARG.



17 CM **NA8239**
22 CM **NA8240**

BARRA EXTENSIBLE PARA RODILLO



O399
LARGO 2.25 M

PISTOLA PARA PINTAR



R555

BAJA PRESIÓN
PARA COMPRESOR
CARGA SUPERIOR 600 ML

PISTOLA PARA PINTAR



R550

BAJA PRESIÓN
PARA COMPRESOR
CAPACIDAD: 800 ML

PISTOLA PARA PINTAR



R560

ALTA PRESIÓN
PARA COMPRESOR
CAPACIDAD: 1000 ML

MEMBRANA FÁCIL

440 CM3

BLANCA **NA8667**

NEGRA **NA8666**

INCOLORA **NA8669**



NUEVO

MEMBRANA LÍQUIDA

EXTRA
POWERTECH



10 KGS.

BLANCO **NA8560**

VERDE **NA8561**

ROJO **NA8562**

20 KGS.

BLANCO **NA8539**

VERDE **NA8540**

ROJO **NA8541**

LÁTEX INTERIOR - EXTERIOR BLANCO

EXTRA
POWERTECH



10 LITROS **NA8598**

20 LITROS **NA8597**

LÁTEX INTERIOR BLANCO

EXTRA
POWERTECH

NUEVO



1 LITRO **NA8596**

4 LITROS **NA8563**

10 LITROS **NA8595**

20 LITROS **NA8594**

SELLADOR FIJADOR



1 LITRO

NA8553

4 LITROS

NA8554

ENDUIDO INTERIOR



1 LITRO

NA8542

4 LITROS

NA8543



industria argentina

CINTA TEFLÓN

LARGO: 10 M

- 1/2" **NA8320**
- 3/4" **NA8321**
- 1" **NA8322**



CINTA TEFLÓN ALTA DENSIDAD

LARGO: 10 M

- 1/2" **NA8497**
- 3/4" **NA8498**



CINTA TERMOCONTRAIBLE

LARGO: 10 M

- 1/8" **NA8499**
- 3/16" **NA8500**
- 1/4" **NA8501**



PRECINTOS DE NYLON

- 100MM x 2.5MM **NA8182**
- 150MM x 3.6MM **NA8183**
- 180MM x 3.5MM **NA8184**
- 200MM x 4.6MM **NA8185**

- 300MM x 4.6MM **NA8186**
- 300MM x 7.6MM **NA8187**
- 350MM x 4.6MM **NA8188**
- 350MM x 7.6MM **NA8189**



CINTA PARA REFRIGERACIÓN

LARGO: 20 M

- SIN ADHESIVO **NA8405**
- CONADHESIVO **NA8404**



CINTA AISLADORA PVC

NEGRO

- 19 MM x 5 M x 0.15MM **NA8489**
- 19 MM x 10 M x 0.15MM **NA8392**
- 19 MM x 20 M x 0.15MM **NA8394**

BLANCO

- 19 MM x 10 M x 0.15MM **NA8391**
- 19 MM x 20 M x 0.15MM **NA8393**



CINTA MULTIPRÓPOSITO DUCTAC

ANCHO: 48 MM
LARGO: 9 M

- GRIS **NA8093**
- NEGRO **NA8094**



CINTA DOBLE FAZ DE ESPUMA

- 12MM X 5M **NA8437**
- 18MM X 2M **NA8438**
- 24MM X 2M **NA8439**



CINTA DE PAPEL PARA USO GENERAL AZUL

LARGO: 50 M

- 12 MM **NA8454**
- 18 MM **NA8455**
- 24 MM **NA8456**
- 36 MM **NA8457**
- 48 MM **NA8482**

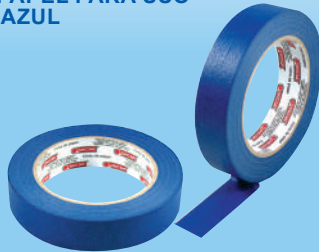

CINTA DE ENMASCARAR

LARGO: 50 M

- 12 MM **NA8095**
- 18 MM **NA8096**
- 24 MM **NA8097**
- 36 MM **NA8098**
- 48 MM **NA8481**



CINTA ANTIDESLIZANTE NEGRA

- NA8441**
25 MM X 5 M



CINTA DE ALUMINIO

- 48MM x 25M **NA8442**
- 48MM x 50M **NA8443**



CINTA DE MARCACIÓN

50 MM X 33 M

- NA8440**
AMARILLA



- NA4143**
AMARILLA Y NEGRA

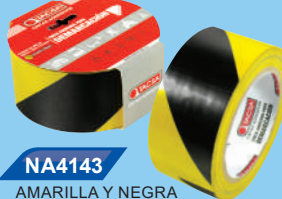

LIMPIA CONTACTOS

- NA5259**
ENAEROSOL
216 MM



PISTOLAS HOT MELT

- NA9003**

10 W
INCLUYE 1 BARRA ADHESIVA



- NA9004**

60 W
INCLUYE 2 BARRAS ADHESIVAS



ADHESIVO ACÉTICO

- NA8512**
INCOLORO
280 ML



ADHESIVO DOBLE CONTACTO

- POMO 50CM **NA8630**
- 125 CM3 **NA8631**
- 250 CM3 **NA8632**
- 500 CM3 **NA8633**
- 1 LT **NA8634**



COLA VINÍLICA

- POTE 125 GMS **NA8635**
- BOT. C/PICO 200 GMS **NA8636**
- POTE 250 GMS **NA8637**
- POTE 500 GMS **NA8638**
- BOT. C/ PICO 800 GMS **NA8639**
- POTE 1LT **NA8640**



PRECINTOS DE NYLON



SET X 100 PCS.
COLOR NEGRO
2.5 X 100 MM **T4801**
3.6 X 150 MM **T4811**
3.6 X 250 MM **T4831**

PRECINTOS CON ALICATE



T485
SET X 201 PCS.

PINZA AMPEROMÉTRICA



T850

CON TESTER - AISLAMIENTO DE 500V
CONTINUIDAD AUDIBLE - INDICADOR
DE BATERÍA BAJA - MIDE AC/DC
VOLTAJE Y RESISTENCIA
DATA HOLD-3 1/2 DIGITOS LCD
LECTURA MÁXIMA 1999

CABLES NORMALIZADOS - HOMOLOGADOS BAJO NORMAS IRAM - PRECIOS POR ROLLO DE 100 M



UNIPOLAR



1 x 1.00MM BLANCO	NA7190B
1 x 1.00MM CELESTE	NA7190C
1 x 1.00MM MARRÓN	NA7190M
1 x 1.00MM NEGRO	NA7190N
1 x 1.00MM ROJO	NA7190R
1 x 1.00MM VERDE-AMAR.	NA7190T
1 x 1.50MM BLANCO	NA7191B
1 x 1.50MM CELESTE	NA7191C
1 x 1.50MM MARRÓN	NA7191M
1 x 1.50MM NEGRO	NA7191N
1 x 1.50MM ROJO	NA7191R
1 x 1.50MM VERDE-AMAR.	NA7191T

1 x 2.50MM BLANCO	NA7192B
1 x 2.50MM CELESTE	NA7192C
1 x 2.50MM MARRÓN	NA7192M
1 x 2.50MM NEGRO	NA7192N
1 x 2.50MM ROJO	NA7192R
1 x 2.50MM VERDE-AMAR.	NA7192T

1 x 4MM BLANCO	NA7193B
1 x 4MM CELESTE	NA7193C
1 x 4MM MARRÓN	NA7193M
1 x 4MM NEGRO	NA7193N
1 x 4MM ROJO	NA7193R
1 x 4MM VERDE-AMAR.	NA7193T

1 x 6MM BLANCO	NA7194B
1 x 6MM CELESTE	NA7194C
1 x 6MM MARRÓN	NA7194M
1 x 6MM NEGRO	NA7194N
1 x 6MM ROJO	NA7194R
1 x 6MM VERDE-AMAR.	NA7194T

BIPOLAR



2 x 0.50MM	NA7196
2 x 0.75MM	NA7197
2 x 1.00MM	NA7198
2 x 1.50MM	NA7199
2 x 2.50MM	NA7200

TIPO TALLER



2 x 0.50MM	NA7201
2 x 0.75MM	NA7202
2 x 1.00MM	NA7203
2 x 1.50MM	NA7204
2 x 2.50MM	NA7205
2 x 4.00MM	NA7206
3 x 1.00MM	NA7207
3 x 1.50MM	NA7208
3 x 2.50MM	NA7209

CABLES | LINEA COMPLETA CON UNA AMPLIA VARIEDAD DE MEDIDAS - PRECIOS POR ROLLO DE 100 M

UNIPOLAR



1 x 1.00MM BLANCO	NA7015B
1 x 1.00MM CELESTE	NA7015C
1 x 1.00MM MARRÓN	NA7015M
1 x 1.00MM NEGRO	NA7015N
1 x 1.00MM ROJO	NA7015R
1 x 1.00MM VERDE-AMAR.	NA7015T
1 x 1.50MM BLANCO	NA7016B
1 x 1.50MM CELESTE	NA7016C
1 x 1.50MM MARRÓN	NA7016M
1 x 1.50MM NEGRO	NA7016N
1 x 1.50MM ROJO	NA7016R
1 x 1.50MM VERDE-AMAR.	NA7016T

1 x 2.50MM BLANCO	NA7017B
1 x 2.50MM CELESTE	NA7017C
1 x 2.50MM MARRÓN	NA7017M
1 x 2.50MM NEGRO	NA7017N
1 x 2.50MM ROJO	NA7017R
1 x 2.50MM VERDE-AMAR.	NA7017T

1 x 4.00MM BLANCO	NA7018B
1 x 4.00MM CELESTE	NA7018C
1 x 4.00MM MARRÓN	NA7018M
1 x 4.00MM NEGRO	NA7018N
1 x 4.00MM ROJO	NA7018R
1 x 4.00MM VERDE-AMAR.	NA7018T

1 x 6.00MM BLANCO	NA7019B
1 x 6.00MM CELESTE	NA7019C
1 x 6.00MM MARRÓN	NA7019M
1 x 6.00MM NEGRO	NA7019N
1 x 6.00MM ROJO	NA7019R
1 x 6.00MM VERDE-AMAR.	NA7019T

BIPOLAR



2 x 0.50MM	NA7021
2 x 0.75MM	NA7022
2 x 1.00MM	NA7023
2 x 1.50MM	NA7024
2 x 2.50MM	NA7025

TIPO TALLER



2 x 0.50MM	NA7026
2 x 0.75MM	NA7027
2 x 1.00MM	NA7028
2 x 1.50MM	NA7029
2 x 2.50MM	NA7030
3 x 1.00MM	NA7031
3 x 1.50MM	NA7032

CABLE HDMI FULL HD



NA7217
LARGO: 1.50 M

CABLE DE AUDIO



NA7009
2 x 0.50 MM | NORMALIZADO

GRAPAS PARA CABLES "VEYKA"



CHATO MARFIL N°8 x 100 PCS.	NA8149
CHATO MARFIL N°10 x 50 PCS.	NA8151
COAXIL NEGRO N°9 x 50 PCS.	NA8150
COAXIL NEGRO N°11 x 50 PCS.	NA8152
TALLER NEGRO N°12 x 25 PCS.	NA8153
TALLER NEGRO N°15 x 20 PCS.	NA8154



PINZA COCODRILO MINI



ROJO **NA7074**
NEGRO **NA7075**

CABLE MINI PLUG



NA7216
3.5 ST | 1.80 M

NA7012
3.5 ST A 2 RCA | 1.50 M

CABLE PARA AUDIO / VIDEO



NA7010
2 RCA | 1.50 M

NA7011
3 RCA | 1.50 M

TIMBRE INALÁMBRICO A PILAS



NA7470
38 MELODIAS

CINTA PASACABLES



CON PUNTERA DE BRONCE
7 M **NA1107**
10 M **NA1108**
15 M **NA1109**
20 M **NA1110**



CINTA PASACABLES



CON ALMA DE ACERO
10 M **NA1116**
15 M **NA1117**
20 M **NA1118**



ZAPATILLA MÚLTIPLE



NA7094
1.5 M CON TECLA
5 TOMAS

ZAPATILLA MÚLTIPLE



NA7182
5 M CON TECLA
5 TOMAS

ZAPATILLA MÚLTIPLE REFORZADA



NA7096
SIN TECLA



NA7097
CON TECLA

BASE DOBLE



EXTENSIÓN
2 PATAS **NA7004**
3 PATAS **NA7005**

DUPLO



2 ESPIGAS CHATAS **NA7383**
2 PERNOS REDONDOS **NA7382**

TRIPLE MULTINORMA



REFORZADO
2 PATAS **NA7091**
3 PATAS **NA7092**

ADAPTADOR CUBO 5 TOMAS

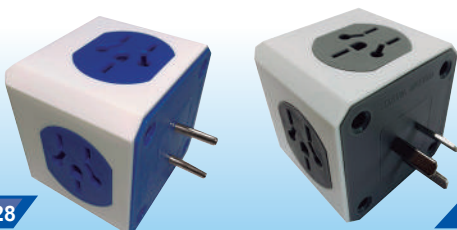

NA7528
2 PATAS

NA7527
3 PATAS

ADAPTADOR CUBO 4 TOMAS - 2 USB



NA7529
3 PATAS

NA7530
CON CABLE DE 1.5 MTS

PORTA LÁMPARAS



NA7489
CON CHICOTE



NA7490
2 PIEZAS



NA7080
3 PIEZAS



NA7081
RECEPTÁCULO RECTO



NA7082
RECEPTACULO CURVO



NA7492
FLORÓN PORTALÁMPARAS

ACCESORIOS PARA CABLE COAXIL

MACHO CON ROSCA



NA7211
RG 59
PACK x 100 UNIDADES

MACHO CON ROSCA



NA7212
RG 6
PACK x 100 UNIDADES

ADAPTADOR TV



NA7213
HEMBRA PIN FINO
MACHO PIN GRUESO

ENTRE ROSCA DOBLE HEMBRA



NA7214
HEMBRA PIN GRUESO
MACHO PIN FINO

NA7215
PIN FINO

DERIVADOR PARA COAXIL



COMPLETO
2 SALIDAS **NA7040**
3 SALIDAS **NA7041**
4 SALIDAS **NA7042**

FICHA PARA TV



PIN GRUESO **NA7052**
PIN FINO **NA7051**

FICHA PARA PLANCHA O CALEFON

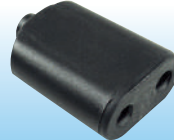

NA7053

FICHA PARA PLANCHA O CALEFON



NA7381
REFORZADA

FICHA MACHO | HEMBRA 10A-BLANCO

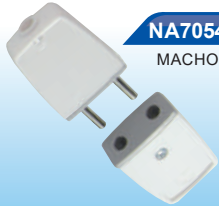

NA7054
MACHO

NA7057
HEMBRA

FICHA MACHO | HEMBRA 10A-MARFIL



NA7056
MACHO

NA7059
HEMBRA

FICHA MACHO | HEMBRA 10A-NEGRO



NA7055
MACHO

NA7058
HEMBRA

FICHA MACHO | HEMBRA RICHY 3 PERNOS - 10 AMP



NA7457
HEMBRA

NA7456
MACHO

FAROL DE PARED



TIPO ANTIGUO
220V PLÁSTICO
SOPORTE SUPERIOR
BLANCO **NA7047**
NEGRO **NA7048**

APLIQUE DIFUSOR BIDIRECCIONAL



NA7483
• MATERIAL: POLIPROPILENO
• PARA USO INTERIOR O EXTERIOR
• FÁCIL DE INSTALAR

APLIQUE DIFUSOR TRIDIRECCIONAL



NA7376
• FÁCIL DE INSTALAR
• DISEÑO DECORATIVO
• DE USO EXTERIOR
• APTO PARA LÁMPARAS DE BAJO CONSUMO

TORTUGA PORTALÁMPARA



PARA LÁMPARA DE BAJO CONSUMO
[No incluye lámpara]
BLANCO **NA7174**
NEGRO **NA7175**



INTERRUPTOR BIPOLAR EXTERIOR 20A



NA7072

NEGRO



NA7071

NARANJA

PERILLA TORPEDO

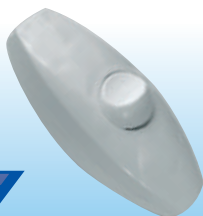

NA7073

BLANCA

LINTERNA 2 ELEMENTOS



T170

PARA PILA D
PLÁSTICA CON MANGO DE GOMA

LAMPARAS LED 220V 15.000 H DE DURACIÓN

POTENCIA	9W		12W		15W	
LUMENS	675LM		900LM		1190LM	
ROSCA	E-27					
CÓDIGO	NA7437	NA7438	NA7439	NA7440	NA7441	NA7442
COLOR	luz cálida	blanco frío	luz cálida	blanco frío	luz cálida	blanco frío



REFLECTOR LED - TECNOLOGÍA SMD



NA7484 720LM 10W

NA7454 1900LM 30W

NA7428 1440LM 20W

NA7455 3100LM 50W

NA7485 6000LM 100W

- BLANCO FRÍO
- DURACIÓN: 25.000 H
- APTO PARA COMERCIOS, OFICINAS, HOTELERÍA, RESTAURANTES, EDIFICIOS, CASA QUINTAS, ETC.

LUZ DE EMERGENCIA RECARGABLE LED



NA7385

30 LED



NA7533

60 LED

LÁMPARA GOTA LED E27

5W

NA7444

- BLANCO FRÍO
- 480 Lm | 220V
- DURACIÓN 15.000 H



LÁMPARA GOTA LED E27

5W

NA7493

- CÁLIDA
- 480 Lm | 220V
- DURACIÓN 15.000 H



LÁMPARA LED GLOBO E27

12W

NA7482

- BLANCO FRÍO
- 960 Lm | 220V
- DURACIÓN 15.000 H



LÁMPARA VELA LED E14

5W

NA7498

- BLANCO FRÍO
- 370 Lm | 220V
- DURACIÓN 15.000 H



LÁMPARA VELA LED E14

5W

NA7526

- CÁLIDA
- 375 Lm | 220V
- DURACIÓN 15.000 H



LÁMPARA LED FRÍA E27 H/P

**NA7531
20W**

**NA7497
40W**

- BLANCO FRÍO
- ROSCA ADAPTADOR E-27

**NA7532
30W**

**NA7500
48W**

- PVC
- DURACIÓN 15.000 H



CAJAS PARA LLAVES TÉRMICA

NA7033

1-2 BOCAS
DE SUPERFICIE
O PARA EMBUTIR



NA7034

2-4 BOCAS
DE SUPERFICIE
O PARA EMBUTIR



NA7177

4 - 8 BOCAS



LINEA DE SUPERFICIE EXTRACHATA



**INTERRUPTOR
UNIPOLAR**

50401/2

220V 10A



**PULSADOR
UNIPOLAR**

50402/2

220V 10A



**TOMACORRIENTE
BIPOLAR**

50405/2

CON TIERRA / 220V 10A



**1 INTERRUPTOR UNIPOLAR
+ 1 TOMACORRIENTE BIPOLAR**

50418/2

CON TIERRA / 220V 10A



2 TOMACORRIENTES BIPOLAR

50413/2

CON TIERRA / 220V 10A



**2 INTERRUPTORES
UNIPOLAR**

50409/2

220V 10A



**TOMACORRIENTE BIPOLAR C/
TIERRA 20 A BIPOLARES**

50420/2

CON TIERRA / 220V 20A



NUEVO

INTERRUPTORES DIFERENCIALES BIPOLARES

2 Polos 25A 30mA AC

NA7247



2 Polos 40A 30mA AC

NA7248



**NO PROPAGA LLAMAS
PROTECCIÓN CONTRA
CHOQUES ELÉCTRICOS**

**INTERRUPTORES TERMOMAGNÉTICOS
BIPOLARES**



10 A	NA7249
16 A	NA7250
20 A	NA7251
25 A	NA7252
32 A	NA7253
40 A	NA7254





FICHA MACHO / HEMBRA 3 PERNOS
SALIDA AXIAL

FICHA MACHO / HEMBRA 3 PERNOS
S/L PLANA



BASTIDOR Y TAPAS

BASTIDOR RECTANGULAR



TAPA RECTANGULAR



TAPA RECTANGULAR



TAPA CON BASTIDOR

BASTIDOR TAPA BLANCA



BASTIDOR TAPA
BLANCA/ NEGRO



BASTIDOR ESTANCO BLANCO
TAPA TRANSPARENTE

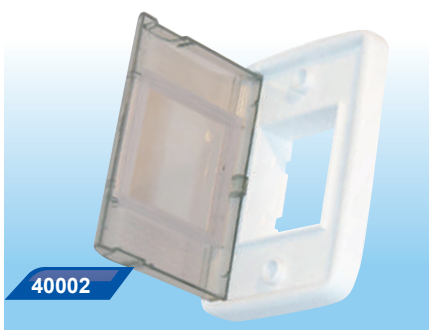

TORNILLOS BASTIDOR



LÁMPARA DE NEON ARMADA



BASE ESTANCO BLANCO





MÓDULOS

LINEA VERONA

40051	INTERRUPTOR 220V 10A UNIPOLAR
40052	INTERRUPTOR 220V 10A PULSADOR
40053	INTERRUPTOR 220V 10A COMBINADO
20059	TOMA BIPOLAR TRANSVERSAL
20068-67	TOMA BIPOLAR
20092	TAPA MODULO CIEGA



40051

40052

40053



20059

CON TIERRA
220V 20A



20068-67

CON TIERRA
220V 10A



20092

MÓDULOS

LINEA PLATINIUM

60092	TAPÓN CIEGO BLANCO
60051	INTERRUPTOR UNIPOLAR 220 10A BLANCO
60052	PULSADOR UNIPOLAR 220V 10A BLANCO
60053	INTERRUPTOR COMBINACIÓN UNIPOLAR 220V 10 A BLANCO
60059	TOMA CORRIENTE BIPOLAR + TIERRA 250V 20A BLANCO
60068-67	TOMA CORRIENTE BIPOLAR + TIERRA T/10A 250 vca BLANCO
60079	TOMA CORRIENTE + TIERRA 20A - DOBLE MODULO BLANCO
60028-27	TOMA CORRIENTE BIPOLAR DOBLE + TIERRA 2X 10A BLANCO
60453	INTERRUPTOR UNIPOLAR 1/2 TECLON COMBINADO BLANCO X2
60353	INTERRUPTOR UNIPOLAR TECLON COMBINADO BLANCO
60031	MODULO INTERRUPTOR UNIPOLAR + CIEGO BLANCO
60032	MODULO 2 INTERRUPTORES UNIPOLAR BLANCO
60034	MODULO 2 INTERRUPTORES UNIPOLAR COMBINADO BLANCO
60145	TOMA RJ 45 - PLATINIUM BLANCO
60146	TOMA USB CARGA 1A - BLANCO
60246	TOMA USB DOBLE CARGA 2A- PLATINIUM BLANCO
60209	TOMA TV CON ACOPLER FINAL PIN FINO ROSCADO 0db BLANCO
60011	TOMA TELEFÓNICO AMERICANO RJ11 4 VIAS BLANCO



60092



60051



60052



60053



60059



60068-67



60079



60028-27



60453



60353



60031



60032



60034



60145



60146



60246



60209



60011



▶▶ SOPORTES NAKAN

SOPORTE DE PARED PARA DVD / BLUE RAY / CONSOLA VIDEO JUEGOS

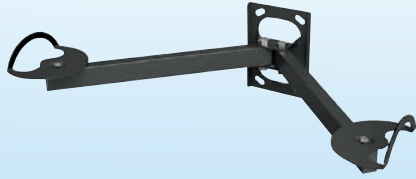

14 a 48cm

SPL-970

SOPORTE DE PARED PARA TV FIJO



DE 32" A 60"

SPL-484

SOPORTE DE PARED PARA TV CON INCLINACIÓN



DE 32" A 65"

SPL-695I



SOPORTE DE PARED



DE 10" A 32"

SPL-570E

EXTENSIBLE GIRATORIO Y BASCULANTE

SOPORTE DE PARED FIJO



DE 17" A 43"

NAK-456

SOPORTE DE PARED



DE 32" A 65"

SPL-780

EXTENSIBLE GIRATORIO Y BASCULANTE

SOPORTE BASCULANTE PARA LCD

DE 14" A 55"

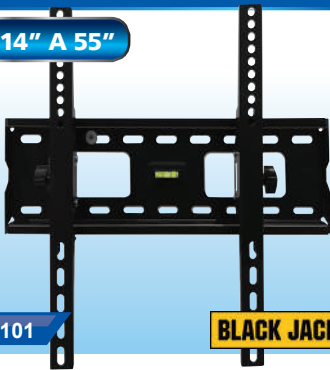

W101

BLACK JACK

SOPORTE PARA LCD FIJO

DE 14" A 42"

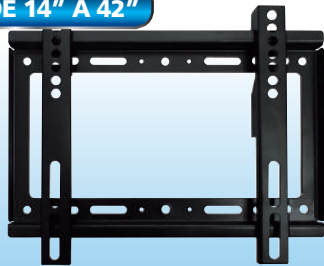

W102

BLACK JACK

SOPORTE PARA LCD CON BRAZO

DE 14" A 42"



W103

BLACK JACK

SOPORTE BASCULANTE PARA LCD CON BRAZO

DE 14" A 55"

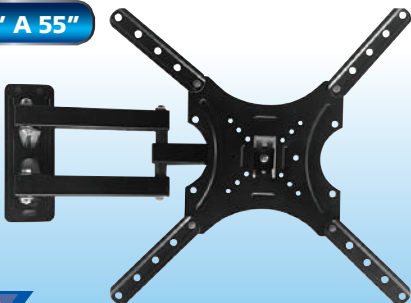

W104

BLACK JACK

SOPORTE BASCULANTE PARA LCD CON BRAZO

DE 26" A 55"

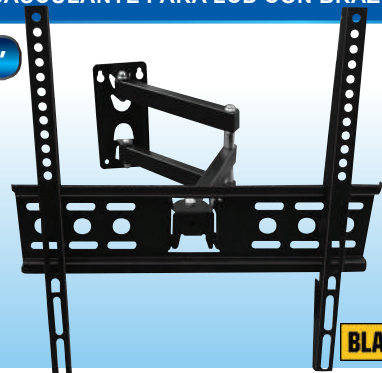

W105

BLACK JACK

HILO SISAL



NA8163

ROLLO X 30 M

HILO DE ALGODON



NA8158

ROLLO X 100 M

HILO CHORICERO AMARILLO



NA8159

ROLLO X 100 M

HILO DE ALBAÑIL



NA8164

ROLLO X 30 M

HILO DE POLIPROPILENO



ROLLO X 50 GRS **NA8160**
ROLLO X 100 GRS **NA8161**
ROLLO X 250 GRS **NA8162**

SOGA PP ELÁSTICA TRENZADA



NA8444

6 MM X 100 MTS

SOGA DE POLIPROPILENO TRENZADA



4 MM X 150 M **NA8251**
5 MM X 100 M **NA8252**
6 MM X 100 M **NA8253**
8 MM X 100 M **NA8254**
10 MM X 100 M **NA8255**

SOGA DE POLIETILENO



4 MM X 200 M **NA8243**
5 MM X 150 M **NA8244**
6 MM X 100 M **NA8245**
8 MM X 100 M **NA8246**
10 MM X 100 M **NA8247**

SOGA DE POLIETILENO ENVAINADA



4 MM X 200 M **NA8248**
5 MM X 150 M **NA8249**
6 MM X 100 M **NA8250**

CABLE DE ACERO

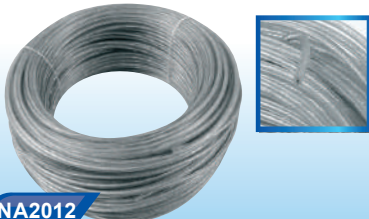

NA2012

TRENZADO FORRADO EN PLÁSTICO - 100 M

CINTA PARA PERSIANA REFORZADA



NA8079

BLANCA
ROLLO X 100 M

CINTA PARA PERSIANA SUPER REFORZADA



NA8080

MARRÓN O VERDE
ROLLO X 100 M

ENROLLADOR PARA CORTINA

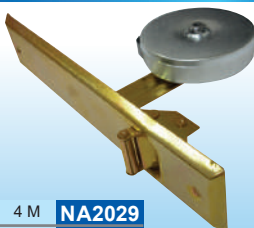

4 M **NA2029**
6 M **NA2030**
8 M **NA2031**

CINTA DE EMBALAR



NA8077

ANCHA
TRANSPARENTE
4.8 CM X 40 MTS

NUEVO

NA8073

ANCHA
TRANSPARENTE
4.8 CM X 100 MTS

ENCINTADORA REFORZADA



O700



CAJAS, GAVETEROS Y ORGANIZADORES

12.5"



NA8485

SAO BERNARDO
CON BANDEJA [CF-32]

16"



NA8487

CON BANDEJA Y GAVETERO
SAO BERNARDO [CF-44]

19.5"



NA8484

CON BANDEJA Y GAVETERO
SAO BERNARDO [CF-43]

17"



NA8325

CON BANDEJA Y
CIERRE METÁLICO
SAO BERNARDO [CF-41]



NA8056

METÁLICA BABY CHICA
MEDIDAS: 300 X 110 X 80 MM

NA8057

METÁLICA BABY GRANDE
MEDIDAS: 380 X 110 X 80 MM



CAJA METÁLICA REFORZADA

N°2 330 X 140 X 130 MM **NA8061**

N°3 390 X 140 X 130 MM **NA8062**

N°4 400 X 170 X 140 MM **NA8063**



NA8129

8,5 X 19,5 X 4,5 CM
6 DIVISIONES FIJAS.

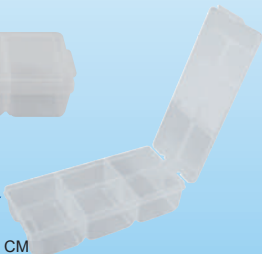

NA8130

16,7 X 19,5 X 4,5 CM
9 DIVISIONES FIJAS.

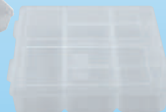

NA8399

CON MANIJA
21 DIVISIONES





NA8131

33,5 X 19,5 X 4,5 CM
17 DIVISIONES FIJAS



NA8132

33 X 24 X 4,5 CM
25 DIVISIONES FIJAS

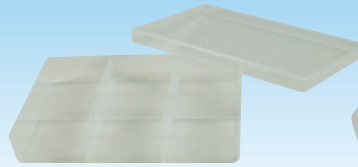

NA8125

CHICO - 6 DIVISIONES
155 X 105 X 25 MM

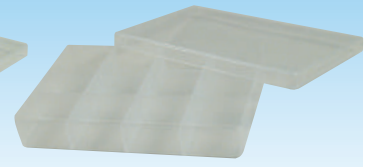

NA8127

CHICO - 12 DIVISIONES
155 X 105 X 25 MM



NA8495

CHICO CON 6 DIVISIONES
CON BISAGRA



NA8496

CHICO CON 12 DIVISIONES
CON BISAGRA

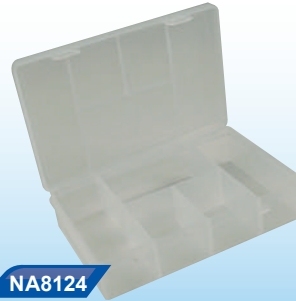

NA8124

GRANDE - 5 DIVISIONES
175 X 115 X 40 MM
CON BISAGRA



NA8126

GRANDE - 6 DIVISIONES
205X 105 X 35 MM
CON BISAGRA

**BOTÍN DE SEGURIDAD
BI-DENSIDAD**

PUNTERA DE ACERO

- TALLE 36 **NA4119**
- TALLE 37 **NA4120**
- TALLE 38 **NA4121**
- TALLE 39 **NA4122**
- TALLE 40 **NA4123**
- TALLE 41 **NA4124**
- TALLE 42 **NA4125**
- TALLE 43 **NA4126**
- TALLE 44 **NA4127**
- TALLE 45 **NA4128**



ACOLCHADO EN LA PARTE SUPERIOR DE LA CAÑA. OJALILLOS METÁLICOS. PLANTILLA DE CONFORT ANTIMICÓTICA. PUNTERA DE ACERO CERTIFICADA: NORMA IRAM 3643. SUELA POLIURETANO BIDENSIDAD, ANTIDESLIZANTE. DIELÉCTRICA / RESISTENTE A HIDROCARBUROS, FLEXIÓN Y ABRASIÓN / AUTOLIMPIANTE. CAPELLADA: CUERO. FORRO INTERNO: MATERIAL TEXTIL ANTIMICÓTICO.

BOTÍN DE SEGURIDAD HÍBRIDO

PUNTERA DE ACERO

- TALLE 36 **NA4109**
- TALLE 37 **NA4110**
- TALLE 38 **NA4111**
- TALLE 39 **NA4112**
- TALLE 40 **NA4113**
- TALLE 41 **NA4114**
- TALLE 42 **NA4115**
- TALLE 43 **NA4116**
- TALLE 44 **NA4117**
- TALLE 45 **NA4118**



ACOLCHADO EN LA PARTE SUPERIOR DE LA CAÑA. OJALILLOS METÁLICOS. PLANTILLA DE CONFORT: POLIURETANO INYECTADO BAJA DENSIDAD, COBERTURA ANTIMICÓTICA. PUNTERA DE ACERO CERTIFICADA: NORMA IRAM 3643. SUELA: PVC, DISEÑO ANTIDESLIZANTE. DIELÉCTRICA / RESISTENTE A HIDROCARBUROS, FLEXIÓN Y ABRASIÓN / AUTOLIMPIANTE. CAPELLADA: CUERO. FORRO INTERNO: MATERIAL TEXTIL ANTIMICÓTICO.

BOTAS OMBU

- Nº 38 **NA4071**
- Nº 39 **NA4008**
- Nº 40 **NA4009**
- Nº 41 **NA4010**
- Nº 42 **NA4011**
- Nº 43 **NA4012**
- Nº 44 **NA4013**
- Nº 45 **NA4014**
- Nº 46 **NA4072**

OMBU



PARA USO RURAL O INDUSTRIAL. CAÑA ALTA - REFORZADAS. FORRO INTERIOR AFELPADO.

BOTÍN DE SEGURIDAD

PUNTERA DE ACERO

- TALLE 39 **NA4016**
- TALLE 40 **NA4017**
- TALLE 41 **NA4018**
- TALLE 42 **NA4019**
- TALLE 43 **NA4020**
- TALLE 44 **NA4021**
- TALLE 45 **NA4022**



ZAPATILLA DE TRABAJO - FEBO

- TALLE 38 **NA41441**
- TALLE 39 **NA4144**
- TALLE 40 **NA4145**
- TALLE 41 **NA4146**
- TALLE 42 **NA4147**
- TALLE 43 **NA4148**
- TALLE 44 **NA4149**
- TALLE 45 **NA4150**



**PUNTERA DE ACERO
MÁS RESISTENTE!**

SUELA DE GOMA



PROTECTOR AUDITIVO



NA4045
TIPO COPA
MEDIA ATENUACIÓN

PROTECTOR AUDITIVO



NA4283
TIPO COPA
ALTA ATENUACIÓN

PROTECTOR AUDITIVO



NA4070
ENDOAUURAL
DE SILICONA

CARETA PARA SOLDAR

NO INCLUYE VIDRIOS



NA4063
VISOR FIJO CON ARNÉS
A CREMALLERA

CARETA PARA SOLDAR

NO INCLUYE VIDRIOS



NA4049
VISOR MOVIL CON ARNÉS
A CREMALLERA

POLICARBONATO TRANSPARENTE PARA CARETA P/ SOLDAR

NA4060
RECTO 105 X 50 MM
PRECIO X UNIDAD



VIDRIO PARA CARETA P/ SOLDAR

NA4061
VERDE DIN 7 RECT 105 X 50 MM
PRECIO X UNIDAD



CINTA DE PELIGRO



ROLLO X 50 M **NA4035**
ROLLO X 200 M **NA4036**

BARBIJO DESCARTABLES N95 - FRAVIDA



NA4159
SET X 75 PCS.

BARBIJO DESCARTABLES FRAVIDA



NA4007
SET X 50 PCS.

PROTECTOR FACIAL ECONÓMICO



NA4281

PROTECTOR FACIAL B/P



NA4282

PROTECTOR FACIAL REFORZADO

- *ANATÓMICO
- *FLEXIBLE
- *LAVABLE
- *REUTILIZABLE

PRODUCTOR: ELECTROSA
JELOZ



NA8610
• AJUSTE POR BANDA ELÁSTICA
• MATERIAL: POLIPROPILENO INYECTADO
• VISOR PET, ESTERILIZABLE,
ALTA VISIBILIDAD

PROTECTOR FACIAL



NA4046

ACRÍLICO TRANSPARENTE

ANTEOJOS DE SEGURIDAD

PROTECCION FRONTAL CONTRA GOLPES , IMPACTO DE PARTICULAS , POLVOS Y CHISPAS.
AUMENTO DE CONTRASTE, PROFUNDIDAD, FILTRO Y PROTECCIÓN LUMINICA.
LENTE DE POLICARBONATO.



NA4151

MP5 CRISTAL



NA4152

MP5 AMARILLO



NA4153

MP5 HUMO

ANTEOJOS DE SEGURIDAD

PATILLA
REGULABLE



NA4002

• INCOLORO



NA4003

• SMOKE



NA4052

• AMARILLO

ANTIPARRAS DE SEGURIDAD



NA4001

CON VENTILACIÓN DIRECTA

ANTIPARRA P/SOLDAR - VISOR REBATIBLE



NA4062

- 2 OPCIONES EN UN MISMO MODELO: VISOR FIJO Y REBATIBLE, CIERRE HERMÉTICO Y DESMONTABLE.
- SU DISEÑO PERMITE EL USO DE ANTEOJOS.
- 6 VALVULAS DE VENTILACIÓN INDIRECTAS.
- BANDA DE SUJECIÓN REGULABLE.
- CUERPO FLEXIBLE PARA MEJOR ADAPTACIÓN AL CONTORNO FACIAL, CUBRE NARIZ INCORPORADO.

*NO INCLUYE VIDRIOS

PROTECTOR RESPIRATORIO CONFOS I

NO INCLUYE FILTROS



NA4064

UN FILTRO



PROTECTOR RESPIRATORIO CONFOS II

NO INCLUYE FILTROS



NA4065

DOBLE FILTRO



FILTROS - PRECIO POR PAR



NA4067

PARA GASES, ÁCIDOS Y VAPORES ORGÁNICOS
CLORO - ÁCIDO CLORHÍDRICO
ACIDO SULFUROSO

NA4068

PARA PARTICULADOS SÓLIDOS Y ACUOSOS
CLORO - ÁCIDO CLORHÍDRICO
ÁCIDO SULFUROSO

NA4066

PARA VAPORES ORGÁNICOS
SOLVENTES, ESMALTES, LACAS Y PINTURAS



CABO DE AMARRE DE SUJECIÓN



NA4154

1,5 M DE LARGO REGULABLE CON 2 MOSQUETONES ESTAMPADOS DE 18 MM

ELEMENTO DE AMARRE ANTICAIDAS



NA4155

DOBLE ELASTIZADO DE 1,5 M DE LARGO CON AMORTIGUADOR Y UN MOSQUETON ESTAMPADO ABERTURA 18 MM Y 2 DE ABERTURA 55 MM

ARNÉS ANTICAIDAS



NA4156

CON TOMA ANTICAIDAS DORSAL Y TOMAS DE SUJECIÓN EN LA CINTURA

ARNÉS PARA DESMALEZADORA



NA4157

BANDOLERA REFLECTIVA



NA4006

CHALECO REFLECTIVO DE SEGURIDAD



AMARILLO **NA4033**
NARANJA **NA4034**

FAJA PROTECTORA LUMBAR

FAJA DE SEGURIDAD CON 6 BALENAS

TALLE S	NA4037
TALLE M	NA4038
TALLE L	NA4039
TALLE XL	NA4040
TALLE XXL	NA4041



FAJA DE TRABAJO REFORZADA



6 BALENAS FULL ELAST

TALLE S	NA4132
TALLE M	NA4133
TALLE L	NA4134
TALLE XL	NA4135
TALLE XXL	NA4136



CINTA DE SUJECIÓN CON CRIQUE



NA4100

25 MM X 3 MTS

NA4101

50MM X 9MTS

CINTA PARA SUJETAR CON TRABA DE SEGURIDAD



R200

LARGO 5 M
1"

R201

LARGO 5 M
2"

CASCO DE SEGURIDAD



NA4030

AMARILLO

NA4031

AZUL

NA4032

BLANCO

DELANTAL DE CUERO DE DESCARNE

NUEVO

NA4142

90 X 60 CM



DELANTAL DE CUERO DE DESCARNE CON GOMA PLOMADA

NUEVO

NA4160

90 X 60 CM



GUANTE CERTIFICADO DE DESCARNE - PUÑO CORTO



NA8491

GUANTE CERTIFICADO DE DESCARNE - PUÑO LARGO



NA8550

GUANTE CERTIFICADO DE SOLDADOR



NA8492

GUANTE CERTIFICADO DE DESCARNE - COMBINADO



NA8493

GUANTE CERTIFICADO DE VAQUETA - 1/2 PASEO



TALLE N° 10 **NA8494**
TALLE N° 11 **NA8559**

GUANTE ACRILONITRILLO GAMISOL



NUM. 7 **NA6263**
NUM. 8 **NA6264**
NUM. 9 **NA6265**
NUM. 10 **NA6266**

GUANTE ALGODÓN Y POLIURETANO - GAMISOL



NA6261

GUANTE POLIESTER Y NITRILLO - GAMISOL



NA6262

GUANTE POLIESTER Y POLIURETANO - GAMISOL



NA6260

GUANTE INDUSTRIAL SUNCHO



DE GOMA
TALLE S **NA83271**
TALLE M **NA8327**
TALLE L **NA8328**
TALLE XL **NA8329**

GUANTE DOMÉSTICO TACOLATEX



NUM. 8 **NA2240**
NUM. 9 **NA2241**
NUM. 10 **NA22411**
NUM. 10.5 **NA22412**

GUANTE TERRY CLOTH PESADO



NA8349
MEZCLA DE ALGODON Y POLIESTER
PRECIO X PAR

GUANTES MOTEADOS



NA6012
PRECIO X PAR



GUANTES MOTEADOS



NA6011
PRECIO X PAR



GRASA DE LITIO



125 G **NA8134**
 250 G **NA8135**
 900 G **NA8136**

GRASA DE RODAMIENTOS



125 G **NA8137**
 250 G **NA8138**
 900 G **NA8139**

GRASA GRAFITADA



125 G **NA8140**
 250 G **NA8141**
 900 G **NA8142**

GRASA VASELINADA SILICONADA



125 G **NA8143**
 250 G **NA8144**
 900 G **NA8145**

FUNDENTE PARA SOLDAR Y ESTAÑAR



NA8121
 CONTENIDO: 100 G

DECAPANTE PARA SOLDAR Y ESTAÑAR



NA8102
 CONTENIDO: 75 G

LITARGILIO



NA8165
 CONTENIDO: 100 G

GLICERINA

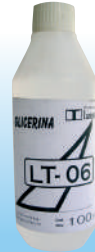

NA8133
 CONTENIDO: 100 G

GRAFITO EN POLVO



23 G **NA8146**
 70 G **NA8147**

SELLA ROSCAS



25 G **NA8241**
 120 G **NA8242**

SILICONA EN BARRAS



PRECIO X KG
 8 MM **T880**
 11 MM **T881**

ACEITE LUBRICANTE MULTIUSO



NA8039
 CONTENIDO: 100 ML

LUBRICANTE MULTIUSO "LUBRIPOWER"



POR UNIDAD **NA8166**
 PROMO 12 UN **NA8190**

LUBRICANTE 1LT PARA MOTOSIERRA



- MANTIENE LIMPIAS LAS LUMBRERAS DE LOS MOTORES.
- REDUCE LA FORMACIÓN DE HUMOS.

SEMISINTÉTICO
 P/ MOTOR 2 TIEMPOS **NA5155**
 PARA CADENA **NA5156**

LLAVE CRUZ

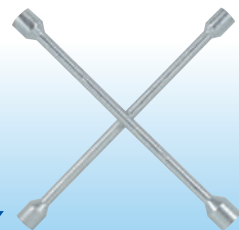

R250
 MÚLTIPLES MEDIDAS

BOMBA MANUAL GRANDE



P220
PARA FLUIDOS
LARGO 45 CM



P225
PARAFLUIDOS
LARGO 80 cm
PARA TAMBOR
DE 200 LTS

ACEITERA METÁLICA



P200
CON PICO FLEXIBLE
CAPACIDAD 150 G



P210
CON PICO FLEXIBLE
CAPACIDAD: 300 G

BOMBA CHUPADORA DE NAFTA



P240
CON MANGUERA

GRASERA METÁLICA

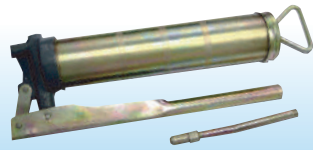

P180
CON PICO ALEMITE
CAPACIDAD 400 G

GRASERA METÁLICA



P185
PARA TAMBORES

BOMBA TRASVASADORA DE ACEITE



P230
PARA TAMBOR DE 200 LTS

LLAVE SACAFILTROS A CADENA



R340

SACAFILTRO DE BANDA



R342
83 A 95 MM

SACAFILTRO UNIVERSAL



R341
3 PATAS MOLETEADAS

LLAVE SACABUJIAS ARTICULADA



16MM **R330**
21MM **R332**

SOPORTE ESTANDAR



R210
PARA 2 TN. SET X 2 PCS.

SOPORTE REFORZADO



R220
PARA 2 TN. SET X 2 PCS.

CRIQUE HIDRÁULICO



MODELO BOTELLA
2 TN **R260**
4 TN **R261**
20 TN **R270**
(PI/ CAMIONES Y COLECTIVOS)

CRIQUE HIDRÁULICO LÍNEA PESADA



LÍNEA PESADA
10 TN **R271**
16 TN **R272**
20 TN **R273**
30 TN **R274**
50 TN **R275**

IDEAL PARA SU USO EN CAMIONES Y COLECTIVOS

SOGA DE ARRASTRE



R240
CON GANCHOS METÁLICOS
LARGO 4 M.

LINGA DE ACERO PARA REMOLQUE



R241

MALACATE NAÚTICO



R231
PARA 1000 LB.
REFORZADO

EXPANSOR HIDRÁULICO



A410 **A420**
KIT COMPLETO CON PROLONGACIONES
VALIJA PLÁSTICA INCLUIDA



GUINCHE ELEVADOR DE MOTOR



A290

HIDRAÚLICO
CAPACIDAD 1 TN

SET DE AROS SEGUER



R016

TAMAÑOS SURTIDOS
SET X 148 PCS - EXTERNOS

O'RING SURTIDOS



SET X 50 PCS. **R015**
SET X 225 PCS. **R010**

ACOPLES RÁPIDOS



R570

SET X 5 PCS.

PISTOLA DE AIRE PARA COMPRESOR



R490

CON 3 PICOS

PISTOLA DE AIRE PARA COMPRESOR



R520

CON MANÓMETRO

CABLES PARA BATERÍA



200 A **R300**
400 A **R301**

SOGA ELÁSTICA



SET X 4 PCS.
CON GANCHOS METÁLICOS

36" **R060**
40" **R061**

INFLADOR PLÁSTICO CON FUELLE



R105

TAMAÑO: 4.5"
PARA TODO TIPO DE INFLABLES

INFLADOR DE PIE



R110

CON PICOS PARA AUTO,
BICICLETA, PELOTA, ETC.

INFLADOR PLÁSTICO



R115

100 x 410 MM
IDEAL PARA INFLABLES
DE CAMPING Y PILETAS
MÚLTIPLES PICOS

INFLADOR CROMADO



CON BOMBA DE
RETENCIÓN
Y 2 PICOS DE
BRONCE

250 MM **R119**
450 MM **R120**

EMBUDOS PLÁSTICOS



P195

SET X 3 PCS.

EMBUDO PLÁSTICO



P190

CON PICO FLEXIBLE
Y FILTRO METÁLICO

LINGA PARA BICICLETA



Q390
LARGO 650 MM
Ø 8,5 MM

LINGA PARA BICICLETA



Q400
REFORZADA - LARGO 1M

LINGA PARA BICICLETA / MOTO

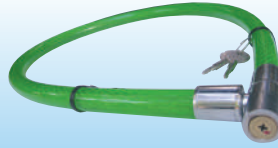

Q393
LARGO: 1,05 M x Ø20 MM

LINGA PARA MOTO



Q440
REFORZADA
LARGO: 1,05 M x Ø24 MM

KIT PARA REPARAR BICICLETA



R070
CON CALZADOR, LLAVE, RASPADOR, PARCHES, GOMINES Y PEGAMENTO.

TRABA DE SEGURIDAD



MODELO "U"
CON BARRA DE ACERO REFORZADO
180 x 245mm **Q410**
180 x 320mm **Q411**



MOSQUETÓN DE ALUMINIO

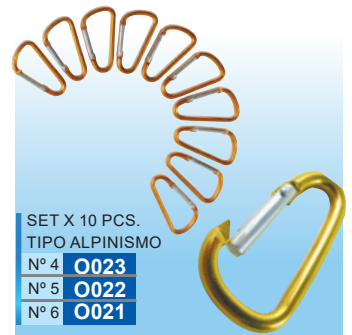

SET X 10 PCS.
TIPO ALPINISMO
Nº 4 **O023**
Nº 5 **O022**
Nº 6 **O021**

BARRA ANTIRROBO



Q420
PARA VOLANTE

CANDADO PESADO GRIS



25 MM **Q180**
32 MM **Q181**
38 MM **Q182**
50 MM **Q183**
63 MM **Q184**

CUÑA TRABA PUERTA



NA2028
GOMA



NA2316
PVC CRISTAL

PASADOR METÁLICO



Q040
DORADO

CADENA DE SEGURIDAD



Q060
DORADA PARA PUERTA



Q070
REFORZADA CON PASADOR

MIRILLA DE BRONCE PARA PUERTA

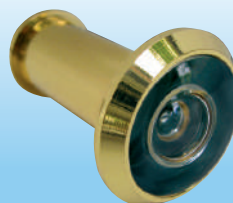

Q080
ÁNGULO DE VISIÓN: 180°

CERRADURA PARA CAJÓN



Q377
PARA CAJÓN



CERRADURA DOBLE PALETA - 4 COMBINACIONES

CE-1120

- FRENTE CHICO
- SISTEMA DOBLE PALETA CON 4 PLACAS
- 2 LLAVES DE BRONCE
- BOCALLAVE Y CONTRAFRENTE

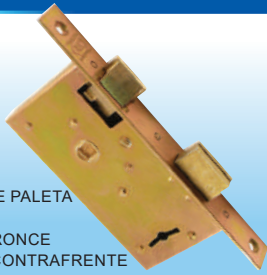

CE-1125

- FRENTE ANCHO
- SISTEMA DOBLE PALETA CON 4 PLACAS
- 2 LLAVES DE BRONCE
- BOCALLAVE Y CONTRAFRENTE

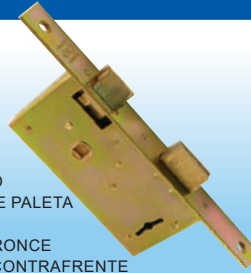

CERRADURA DOBLE PALETA 4 COMBINACIONES

CE-1200

- FRENTE LARGO, CAJA GRANDE
- SISTEMA DOBLE PALETA CON 4 PLACAS
- 2 LLAVES DE BRONCE
- BOCALLAVE Y CONTRAFRENTE



CERRADURA DOBLE PERNO

6 COMBINACIONES

CE-1002

- SISTEMA DOBLE PERNO CON 6 PLACAS
- 2 LLAVES DE BRONCE
- BOCALLAVES Y CONTRAFRENTE



CERROJO DOBLE PERNO

6 COMBINACIONES

CE-5002

- SISTEMA DOBLE PALETA CON 4 PLACAS
- 2 LLAVES DE BRONCE
- BOCALLAVE Y CONTRAFRENTE



MÉNSULAS METÁLICAS

25 X 30 CM **Q021**
30 X 35 CM **Q022**



CERRADURA PARA PUERTA NICHOS DE GAS

CE-190

- SISTEMA DE PESTILLO MECÁNICO
- TRATAMIENTO GALVANOPLÁSTICO
- NUEZ CUADRADA DE NYLON CON U.V.
- APLICABLE EN PUERTAS DE NICHOS DE GAS



PICAPORTE DE POLIPROPILENO

INCLUYE TORNILLOS

NA8411

BLANCO

NA8412

NEGRO



MÉNSULAS PARA AIRE ACONDICIONADO

42CM **NA8177**
49CM **NA8178**



MANIJA MINISTERIO

NA8175

DE ALUMINIO



NA8176

DE BRONCE PULIDO



NA8476

DE BRONCE PLATIL

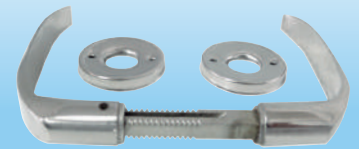

RUEDAS DOBLES GIRATORIAS BASE CUADRADA

32MM **A464**
40MM **A466**



RUEDAS GIRATORIAS BASE CUADRADA

A465
SET X 4 PCS
32 MM.



REGATONES PLÁSTICOS

- ✓ PARA RECICLAR, RENOVAR MUEBLES, CUIDAR Y PROTEGER LOS PISOS, EVITAR RAYARLOS.
- ✓ PROTEGE EXTREMOS DE REPOSERAS, PATAS DE MESA O SILLAS EVITANDO SU DAÑO Y EL DE SU JARDÍN

REGATÓN REGULABLE

X 25 UNIDADES

CHICO 3/8"	NA0523
CHICO 5/16"	NA0524
GRANDE 3/8"	NA0525



INTERIOR



REGATÓN REDONDO

X 50 UNIDADES

5/8" (16MM)	NA0539
3/4" (19MM)	NA0540
7/8" (22MM)	NA0541
1" (25MM)	NA0542
1 1/4" (32MM)	NA0543
1 1/2" (38MM)	NA0544

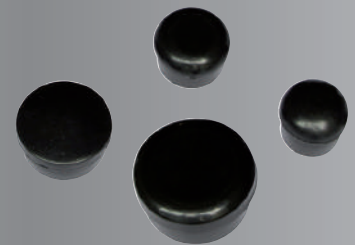

REGATÓN RECTANGULAR

X 50 UNIDADES

15 X 25	NA0545
15 X 30	NA0546
20 X 30	NA0547
20 X 40	NA0548
20 X 50	NA0549



REGATÓN CUADRADO

X 50 UNIDADES

17 X 17	NA0553
20 X 20	NA0554
25 X 25	NA0555
30 X 30	NA0556
35 X 35	NA0557
40 X 40	NA0558 X 25 U.

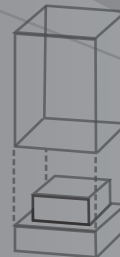
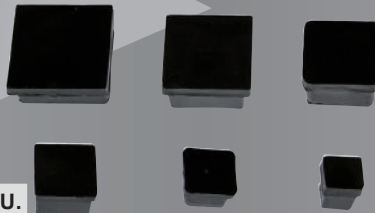

EXTERIOR

REGATÓN REDONDO

X 50 UNIDADES

5/8" (16MM)	NA0501	1 1/4" (32MM)	NA0505
3/4" (19MM)	NA0502	1 3/8" (35MM)	NA0506
7/8" (22MM)	NA0503	1 1/2" (38MM)	NA0507
1" (25MM)	NA0504	2" (50MM)	NA0508 X 25 U.



REGATÓN DE GOMA

X 1 UNIDAD

N°19	NA0570
N°22	NA0571
N°25	NA0572
N°30	NA0573

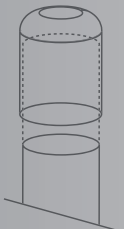



REGADOR PISTOLA



NA6022

CON ADAPTADOR PARA MANGUERA

REGADOR PLÁSTICO



NA6023

GIRATORIO

REGADOR DE BRONCE GIRATORIO

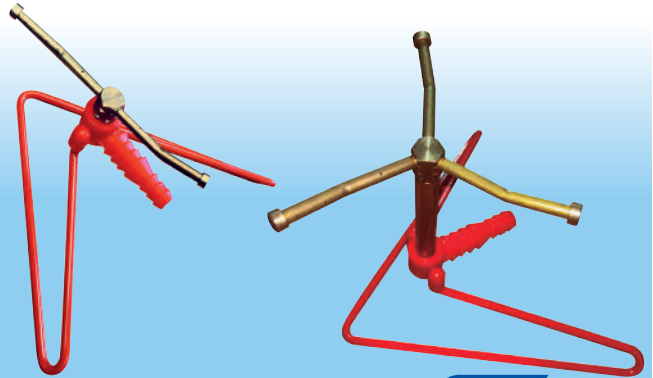

NA6025

Nº 1

NA6024

Nº 3

REGADOR PLÁSTICO



NA6026

MODELO SAPITO

LANZA DE RIEGO PLÁSTICO



NA6013

MEDIDAS: 1/2" - 3/4"

MANGUERA RETRACTIL 15 M CON PISTOLA



NA6175

MANGUERA EN ESPIRAL QUE VUELVE A SU FORMA ORIGINAL DESPUÉS DE SU USO. MANGO PLÁSTICO ANATÓMICO. INCLUYE CONECTORES PLÁSTICOS QUE SE ADAPTAN A LA CANILLA Y A LA PISTOLA.



MEDIO GIRO - GRIFERIA PLÁSTICA

ACOPLE RÁPIDO

PARA REPARAR PINCHADURAS DE CAÑOS PLÁSTICOS Y METÁLICOS

1/2" **NA6044**

3/4" **NA6045**



REGADOR PLÁSTICO MODELO SAPITO

NA6048



CANILLA ARGENT ESFÉRICA 1/2"



NA5014

DUCHADOR MÓVIL LUJO CROMADA



NA5137

•DIAMETRO: 70 MM

DUCHA MÓVIL LUJO CROMADA



NA5191

•DIAMETRO: 50 MM

CANILLA ESFÉRICA



1/2" **NA5129**

3/4" **NA5130**

CANILLA



CONVÁLVULA

1/2" **NA5131**

3/4" **NA5132**

CANILLA PARA LAVARROPAS



NA5133

PLÁSTICA 1/2"

VÁLVULA ESFÉRICA



BICAPA

1/2" **NA5134**

3/4" **NA5135**

1" **NA5136**

MANGUERAS

PARA RIEGO ECONÓMICA

NUEVO

NA6016
1/2" X 20M



PARA RIEGO

REFORZADA
MATERIAL VIRGEN
1/2" X 15 M **NA6212**
1/2" X 25 M **NA6017**
3/4" X 25 M **NA6107**



PARA RIEGO
ALTA RESISTENCIA
MALLADO VERDE
ROLLO DE 25 M

NA6018

NA6106
3/4"



**PORTA MANGUERA
PARA PARED**

NUEVO

NA6021



UNIÓN PARA MANGUERA

NA6033
1/2"

NA6034
3/4"

NA6035
REDUCCIÓN 3/4" A 1/2"



MANGUERA P/LAVARROPAS

NA2046

PARA CARGA
LARGO: 1.80 M



NA2047

PARA DESCARGA
LARGO: 1.80 M

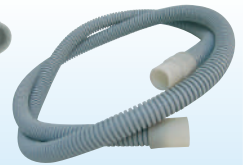

TRANSPARENTE

ROLLOS DE:
6 X 9-50 M **NA8170**
9 X 12-50 M **NA8171**
12 X 15-50 M **NA8172**
16 X 20-25 M **NA8357**



DE PRESIÓN

CON MALLA
6 MM X 50 M **NA8168**
8 MM X 50 M **NA8169**



PARA GAS

NA8167

8 MM
ROLLO X 25 M



TIJERA CORTA CERCO

N260

TAMAÑO: 10"



**TIJERA DE PODAR
REFORZADA**

N240

TAMAÑO: 8"



SET DE JARDINERÍA

N160

JUEGO X 3 PCS



**RASTRILLO METÁLICO
REFORZADO**

N151

14 DIENTES



**RASTRILLO METÁLICO
REFORZADO**

N155

10 DIENTES



BARREHOJAS PLÁSTICO

NA6046

24 DIENTES



BARREHOJAS PLÁSTICO

NUEVO

NA6255

26 DIENTES





CORTADORA DE CÉSPED

mocar

DISPONIBILIDAD DE REPUESTOS
DE TODOS LOS MODELOS

1 AÑO
GARANTÍA

ELÉCTRICAS

- MOTORES ELÉCTRICOS DE FASE DIVIDIDA Y BAJO CONSUMO
- BASE DE ACERO CON TRATAMIENTO ANTIOXIDANTE
- CONSTRUIDO BAJO NORMAS IRAM, AISLACIÓN CLASE 2
- PINTURA EPOXI
- LLAVE INTERRUPTORA DE SEGURIDAD DOBLE COMANDO

350 MMM (Ø DE CORTE).
CON RECOLECTOR.
1/2 HP.

NAR350

430 MMM (Ø DE CORTE).
CON RECOLECTOR RÍGIDO.
3/4 HP.

NAR400

430 MMM (Ø DE CORTE).
CON RECOLECTOR RÍGIDO.
1 HP.

NAR450

510 MMM (Ø DE CORTE).
CON RECOLECTOR RÍGIDO.
1.5 HP.

NAR510



500 MMM (Ø DE CORTE).
CON RECOLECTOR.
5 HP.

NAR5300

NAFTERA



MOTOR DE 5 HP, DE 4 TIEMPOS CON
VÁLVULAS A LA CABEZA
BASE DE ACERO CON TRATAMIENTO
ANTIOXIDANTE
PINTURA EPOXI
RECOLECTOR RÍGIDO DE 43 LTS.
ANCHO DE CORTE 500MM
REGULADOR DE ALTURA DE
CORTE DE 9 POSICIONES
RUEDAS MACIZAS

NARA01

✓ REGULADOR DE ALTURA
DE CORTE 9 POSICIONES
(OPCIONAL).



NUEVO

NUEVO

CORT. CESPED ELEC.
SAL-LAT 1/2 HP.

NAL330

CORT. CESPED ELEC.
SAL-LAT 1.5 HP.

NAL490

BORDEADORA ELÉCTRICA 600W

VERSA

Industria
Argentina



NA6043

MOTOR MONTADO SOBRE
2 RULEMANES
CARRETE MANUAL
DE 4 SALIDAS
Ø DE CORTE 280 MM
INCLUYE TANZA
Y CARRETEL

CARRETEL Y TANZA PARA BORDEADORA



NA6008
2 SALIDAS



NA6010
4 SALIDAS



NA6042
AUTOMÁTICO
PROFESIONAL



NA6009
AUTOMÁTICO



TANZA
REDONDA 1,5 MM x 15 M **NA6027**
CUADRADA 1,5 MM x 15 M **NA6028**

TANZA EN ROLLO



ROLLO X KG.	Modelo
REDONDA 1.5 MM	NA6029
CUADRADA 1.5 MM	NA6030
REDONDA 2.5 MM	NA6031
CUADRADA 2.5 MM	NA6032
REDONDA 3 MM	NA6052
CUADRADA 3 MM	NA6053

ACOPLE DOBLE



HL036

ACOPLE



HL031
1/2"

HL032
3/4"

ACOPLE CON ADAPTADOR



HL031-T020

ACOPLE CON REDUCCIONES



HL019
1/2" - 3/4" - 1"

LANZA DE RIEGO CON 3 ACOPLES



HL055

REGADOR PISTOLA



N040

- CON ADAPTADOR PARA MANGUERA
- 4 LLUVIAS INTERCAMBIABLES

REGADOR PISTOLA



HL118A2

- 6 LLUVIAS INTERCAMBIABLES
- REFORZADO

REGADOR 3 LANZAS GIRATORIAS



HL200

- CON RUEDAS

REGADOR 3 LANZAS GIRATORIAS



HL087

- CON PINCHE PARA CLAVAR

REGADOR ASPERSOR



NA6051

METÁLICO

TIJERA MULTIUSO



O236

- HOJA DE ACERO
- MANGO BICOLOR
- TAMAÑO: 7.5"

TIJERA DE PODAR



N245

- PUNTA RECTA FINA

TIJERA DE PODAR



N246

- CUCHILLA CAMBIABLE
- TAMAÑO: 9"

TIJERA DE TUSAR



N255

- TAMAÑO: 13"

MANGA PARA CANILLA



HL040

- DE 1/2" Y 3/4"

NAHL040

- X 25 UNIDADES

DERIVADOR



N015

- 2-1 PARA MANGUERA DE RIEGO 3/4" A 1/2"

CARRO PORTA MANGUERA



N010

- CAPACIDAD MÁX: 45 M
- TAMAÑO: 1/2"

PULVERIZADOR FUMIGADOR



CAP. 1 1/2 LTS **N100**
CAP. 2 LTS **N110**

PULVERIZADOR FUMIGADOR



N120

- CAPACIDAD 5 LTS
- CON LANZA Y CORREA

PULVERIZADOR FUMIGADOR



N130

- CON MOCHILA PARA COLGAR, PROFESIONAL
- CAPACIDAD 16 LTS



PRODUCTOS MERCLIN



REMOVEDOR QUITA PINTURA GEL X 1 KG



NA5207

- DECAPANTE EXTRA FUERTE
- ELIMINA PINTURAS SINTÉTICAS, LÁTEX, BARNICES Y LACAS
- NO CHORREA

LIMPIA GRIFERÍA GEL X 500 ML



NA5164

- REMUEVE Y PREVIENE EL SARRO SIN DAÑAR EL METAL
- ACTÚA AÚN DESPUÉS DE APLICADO
- IDEAL PARA LIMPIAR SANITARIOS, AZULEJOS, CERÁMICOS, BAÑADERAS, MÁRMOL, VIDRIOS, ETC.

LIMPIA TAPIZADOS Y ALFOMBRAS X 360 GR



NA3040

ESPUMA LIMPIADORA AEROSOL

DESTAPA CAÑERÍAS GEL X 1 L



NA5149

QUITA SARRO GEL X 500 CC



NA5150

DESENGRASANTE CÁUSTICO X1 L



NA5202

QUITA RESTO DE OBRA X 2 L



NA8517

BARREHOJAS EXTENSIBLE METÁLICO

N145



CABO DE ALUMINIO PARA SACAHOJAS

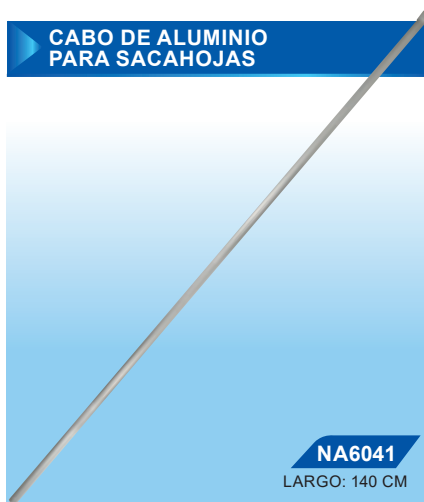

NA6041

LARGO: 140 CM

SACAHOJAS PARA PILETA



NA6038

MALLA: 29 X 23 CM

LIMPIA METALES x 150 GR



NA7995

PARA TODO TIPO DE METALES: BRONCE, PLATA, ALUMINIO, COBRE, ACERO INOXIDABLE, ETC.

DESTAPA CAÑERIAS LÍQUIDO



500 ML NA5028
1000 ML NA5029

QUITA SARRO



NA8191

CONTENIDO 250 CC.

TIJERA USO OFICINA



O239

TAMAÑO: 8"

TIJERA TIPO SASTRE



O238

TAMAÑO: 8"

PRODUCTOS CREMARRAS



NA8000

500 GR.
CON ABRASIVO



NA7999

900 GR.
CON ABRASIVO

ACEITE DE CITRONELLA



NA6207

1 L
REPELENTE DE INSECTOS
PARA USO DE ANTORCHAS EN EXTERIORES



TRAMPA

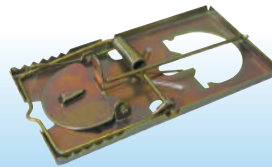

N300

PARA LAUCHAS



N330

PARA RATAS
GRANDE

CEBO RATICIDA BRUMOLINE EN GRANOS



NA2300

TRADICIONAL
X 100 GRS.



NA2301

SUPER
X 100 GRS.



TRAMPA PEGAMENTOSA PARA ROEDORES PEGATRAP



NA6201

CHICA
2 UNIDADES



NA6202

GRANDE
2 UNIDADES

RATICIDA QUICK KILLER



NA6206

X 100 GRS
6 UNIDADES

TALCO HORMIGUICIDA



NA6211

250 G.

INSECTICIDA DERRIBANTE QUICK KILLER

NA6205

100 CM3
DERRIBANTE DE INSECTOS
PARA EL CONTROL DE MOSCAS,
MOSQUITOS Y OTRAS PLAGAS
AL AIRE LIBRE.
EVITA LA EXCESIVA FRECUENCIA
DE FUMIGACIÓN.



INSECTICIDA ALFATHRYN LPU



NA6204

500 CM3

CEBO INSECTICIDA CUCARACHICIDA



NA6203

6 UNIDADES



EXTRA POWER CLEAN

PRESENTACIÓN:
CAJA DE CARTÓN!



CONTIENE:

- 1 BALDE PLÁSTICO CON TAMBOR DE ACERO INOXIDABLE Y PEDAL PLÁSTICO.
- 1 MOPA.
- 1 CABO EXTENSIBLE DE ACERO INOXIDABLE.
- INCLUYE DOSIFICADOR.

2 PAÑOS EXTRA!

R800

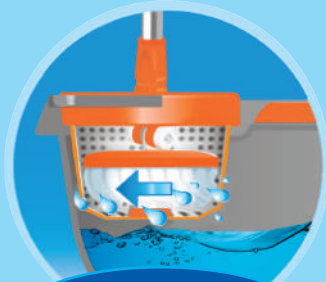

CENTRIFUGADO
TURBO 360°!

CONTIENE:

- 1 BALDE PLÁSTICO CON TAMBOR PLÁSTICO.
- 1 MOPA.
- 1 CABO EXTENSIBLE DE ACERO INOXIDABLE.

R802



CONTIENE:

- 1 BALDE PLÁSTICO CON TAMBOR DE ACERO INOXIDABLE Y PEDAL METÁLICO.
- 1 MOPA.
- 1 CABO EXTENSIBLE DE ACERO INOXIDABLE.
- INCLUYE DOSIFICADOR.

2 PAÑOS EXTRA!

R801



SPRAYMOP CONTIENE:

- 1 BOTELLA DE 500ML PARA COLOCAR LÍQUIDO DE LIMPIEZA
- 1 PAÑO DE MICROFIBRA REUTILIZABLE.
- 1 CABO DE ACERO INOXIDABLE CON MANGO Y GATILLO PLÁSTICO.
- COLORES DISPONIBLES



R810

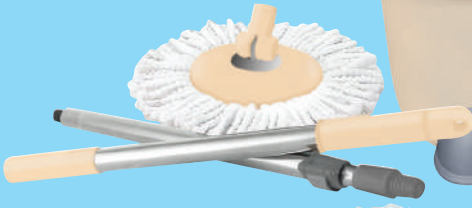

REPUESTOSPRAYMOP

- APTO PARA LAVARROPAS
- 100% MICROFIBRA
- MÁS ABSORCIÓN

R812



REPUESTO MOPA

- APTO PARA LAVARROPAS
- 100% MICROFIBRA
- MÁS ABSORCIÓN

R811



BOYAS PORTA CLORO

HONGO



NA6039

SATELITE

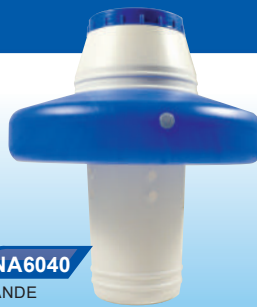

NA6040
GRANDE



NA6047
CHICA

RINCONERO DE 2 PATAS PARA CAÑO 1 1/4"



NA6077

ESQUINERO DE DOS PATAS PARA CAÑO 1 1/4"



NA6070

BASE INCLINADA PARA CAÑO 1 1/4" - 1"

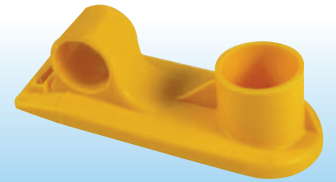

NA6078

RINCONERO DE 1 PATA PARA CAÑO 1 1/4"

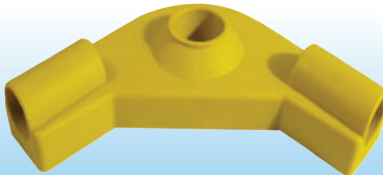

NA6208

ESQUINERO DE 1 PATA PARA CAÑO 1 1/4"

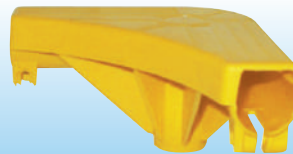

NA6071

SOPORTE "T" PARA CAÑO 1 1/4"



CERRADO

NA6073

ABIERTO

NA6074

TAPÓN DE DESAGOTE



NA6079

REGATÓN DOBLE PARA CAÑO 1 1/4"



NA6076

REGATÓN PARA CAÑO 1 1/4"



NA6075

MANGUERA FLOTANTE



1"	NA6109
1 1/4"	NA6110
1 1/2"	NA6111
2"	NA6112

- ROLLO POR 30 M
- PARA ASPIRACION Y LIMPIEZA DE PISCINAS.
- RESISTENCIA 10°C A 60°C
- RESISTENTE A LA INTEMPERIE
- CON FILTRO SOLAR UV

KIT DE PARCHÉ FAMA



NA8668

INCLUYE PARCHÉ DE 15 X 10 CM Y ADHESIVO



INFLADOR MANUAL



62002

30 CM

INFLADOR ELÉCTRICO



CON 3 ADAPTADORES

NA6195

220 V

COLCHÓN 1 PLAZA



3947

185 X 76 X 22 CM

COLCHÓN 2 PLAZAS



3948

191 X 137 X 22 CM

COLCHÓN 1 PLAZA CON INFLADOR DE PIE INCORPORADO



3951

185 X 76 X 22 CM

COLCHÓN 2 PLAZAS CON INFLADOR DE PIE INCORPORADO



3952

191 X 137 X 22 CM

BOLSA DE DORMIR

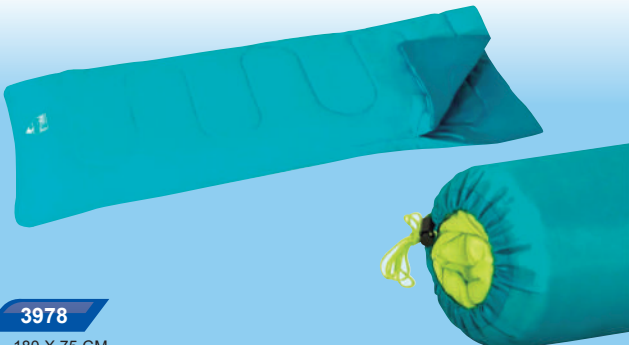

3978

180 X 75 CM

BOLSA DE DORMIR CONFORT



6849

220 X 75 CM

CARPA DE PLAYA

120 X 200 X 95 CM

7005



CARPA PARA 2 PERSONAS

145 X 205 X 100 CM

6857



CARPA PARA 4 PERSONAS

310 X 240 X 130 CM

4933





CEPILLO CURVO



NA6214

LARGO: 50.8 CM

PARCHE DE REPARACIÓN



NA6251

6.5 X 6.5 X 10 UNIDADES

MANGO DE ALUMINIO EXTENSIBLE



NA6217

LARGO: 3.60 M

SACA HOJAS



NA6221

SIN BOLSA
32 X 30.5 CM



NA6222

CON BOLSA
43 X 21 CM

KIT DE LIMPIEZA PARA PILETA



NA6250

LARGO: 2.03 CM



BOMBA FILTRANTE



USAR CON CARTUCHO DE FILTRO TIPO I

NA6247

30 CM
HASTA 8300 L

CARTUCHO DE FILTRO

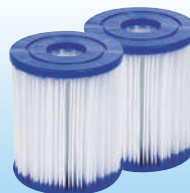

NA6248

TIPO I: 8 X 9 CM X 2 UNIDADES



NA6249

TIPO II: 10.6 X 20.3 CM X UNIDAD

PILETA FAST SET



940 LTS / 1.83M X 0.51M NA6220

1880 LTS / 2.44M X 0.61M NA6242

3800 LTS / 3.05M X 0.76M NA6243

5377 LTS / 3.66M X 0.76M NA6244



COBERTOR DE PILETA FAST SET Y ESTRUCTURAL



3.05 M NA6215

3.66 M NA6216



PILETA FAST SET



6473 LTS / 3.66M X 0.76M NA6246

4678 LTS / 3.05M X 0.76M + BOMBA NA6218

6473 LTS / 3.66M X 0.76M + BOMBA NA6219





CLORO INSTANTANEO

1KG	NA6056
5KG	NA6103
10KG	NA6161
20KG	NA6066
50KG	NA6140



- GRANULADO FINO DE DISOLUCIÓN INSTANTÁNEA.
- CON ESTABILIZANTE QUE LO PROTEGE DEL SOL Y PROLONGA SU ACCIÓN EN EL AGUA.
- APTO PARA TODO TIPO DE PISCINAS.
- DOSIFICACIÓN: (CADA 40.000 L DE AGUA) VERANO: 80 GRS. INVIERNO: 80 GRS SEMANALES.

CLORO INSTANTANEO MULTIACCIÓN

1KG	NA6060
5KG	NA6162
10KG	NA6163
20KG	NA6068



- GRANULADO FINO DE DISOLUCIÓN INSTANTÁNEA.
- CLORO ACTIVO + ALGUCIDA + CLARIFICADOR.
- IDEAL PARA UNA DOSIS DE REFUERZO LUEGO DE TORMENTAS O GRAN AFLUENCIA DE BAÑISTAS.
- DOSIFICACIÓN: (CADA 40.000 L DE AGUA) VERANO: 80 GRS. DIARIOS. INVIERNO: 80 GRS. SEMANALES.

CLORO GRANULADO

1KG	NA6100
5KG	NA6164
10KG	NA6165
20KG	NA6067
50KG	NA6142



- ES UN GRANULADO FINO CON 90% DE CLORO ACTIVO.
- POSEE UN ESTABILIZANTE QUE LO PROTEGE DEL SOL Y PROLONGA SU ACCIÓN EN EL AGUA.
- DISOLUCIÓN LENTA.
- COLOCAR EN PISCINAS REVESTIDAS PARA EVITAR LA DECOLORACIÓN DEL FONDO.
- APTO PARA TODO TIPO DE PISCINAS.
- DOSIFICACIÓN: VERANO: 80 GRS DIARIOS. INVIERNO: 80 GRS MENSUALES.

CLORO EN PASTILLAS

1KG	NA6065
5KG	NA6166
10KG	NA6167
20KG	NA6168
50KG	NA6143



- PASTILLAS GRANDES DE DISOLUCIÓN LENTA DE 5 PASTILLAS X 200 GRS.
- CON ESTABILIZANTE QUE LAS PROTEGE DEL SOL Y PROLONGA SU ACCIÓN EN EL AGUA.
- PARA COLOCAR EN BOYA DOSIFICADORA.
- DURACIÓN DE 7 DÍAS EN VERANO.
- APTO PARA TODO TIPO DE PISCINAS.
- DOSIFICACIÓN: 200 GRS. (CADA 40.000 L DE AGUA)

PASTILLAS CHICAS MULTIACCIÓN

1KG	NA6099
50KG	NA6192



- PASTILLAS DE DISOLUCIÓN LENTA DE 50 GRS.
- ESTABILIZANTE + ALGUCIDA + CLARIFICADOR.
- PARA COLOCAR EN BOYA DOSIFICADORA
- DURACIÓN 7 DÍAS EN VERANO
- APTO PARA PILETAS DE LONA CHICAS.
- DOSIFICACIÓN: (CADA 5.000 L DE AGUA) VERANO: 1 PASTILLA SEMANAL Y REFUERZO DE CLORO SÓLIDO. INVIERNO: 1 PASTILLA UNA VEZ AL MES

CLORO EN PASTILLAS MULTIACCIÓN

1KG	NA6054
5KG	NA6169
10KG	NA6170
20KG	NA6069
50KG	NA6144



- PASTILLAS DE DISOLUCIÓN LENTA DE 200 GRS.
- ESTABILIZANTE + ALGUCIDA + CLARIFICADOR.
- PARA COLOCAR EN BOYA DOSIFICADORA
- DURACIÓN DE 7 DÍAS EN VERANO
- APTO PARA TODO TIPO DE PISCINAS.
- DOSIFICACIÓN: (CADA 40.000 L DE AGUA) VERANO: 2 PASTILLAS SEMANALES. Y REFUERZO DE CLORO SÓLIDO. INVIERNO: 1 PASTILLA CADA 2 SEMANAS.

CLORO OXY POOL 1 KG



NA6254

- FÓRMULA COMPUESTA POR CLORO + OXÍGENO ACTIVO
- EL CLORO SE DISUELVE RÁPIDAMENTE EN EL AGUA Y MATA BACTERIAS Y OTROS MICROORGANISMOS QUE PUEDEN CRECER EN EL AGUA DE LA PILETA MIENTRAS EL OXÍGENO ACTIVO, AYUDA A ELIMINAR LA MATERIA ORGÁNICA AL PRIMER CONTACTO Y AUMENTA EL NIVEL DE OXÍGENO DISUELTO EN EL AGUA DE LA PISCINA.

CLARIFICADOR



1 L	NA6057
5 L	NA6104
10 L	NA6101

- LÍQUIDO FLOCULANTE DE ACCIÓN RÁPIDA.
- AGLOMERA LAS PARTÍCULAS SUSPENDIDAS EN EL AGUA, DEPOSITÁNDOLAS EN EL FONDO PARA SER REMOVIDAS FÁCILMENTE POR EL LIMPIA FONDO.
- LÍQUIDO COMPATIBLE CON CLORO.
- DOSIFICACIÓN: VERANO (CADA 40.000 L DE AGUA): 200 CC SEMANALES.

ALGUICIDA



1 L	NA6058
5 L	NA6105
10 L	NA6102

- PREVIENE Y ELIMINA LA FORMACIÓN DE ALGAS, HONGOS Y BACTERIAS.
- NUEVA FÓRMULA QUE NO PRODUCE ESPUMA.
- PUEDE USARSE EN FORMA COMBINADA CON TODO TIPO DE CLORO.
- DOSIFICACIÓN: (CADA 40.000 L DE AGUA) 400 CC SEMANALES.

CLARIFICADOR EN GEL 75 G.



NA6189

- CLARIFICA EL AGUA DE LA PISCINA, AUMENTANDO LA EFICIENCIA DEL FILTRO Y DISMINUYENDO EL USO DEL LIMPIAFONDO.
- COMPATIBLE CON TODOS TIPOS DE CLORO, Y ESPECIALMENTE RECOMENDADO CUANDO SE UTILIZAN ROBOTS LIMPIA PISCINAS.
- DOSIFICACIÓN: CADA 50.000 LITROS: 1 GEL CLARIFICADOR CADA 20 DÍAS APROXIMADAMENTE.

CORRECTOR DE PH MAS (+) 2 KG



NA6062

- POLVO PARA CORREGIR EL PH DEL AGUA.
- VALORES NORMALES DE PH ENTRE 7.2 Y 7.6 PARA LOGRAR LA MÁXIMA EFICIENCIA DEL CLORO.
- AUMENTA EL PH A VALORES NORMALES.
- GENERALMENTE NECESARIO PARA AGUAS BLANDAS.
- DOSIFICACIÓN: (CADA 40.000 L DE AGUA) 250 GRS. PARA SUBIR 0.1 UNIDAD.

CORRECTOR DE PH MENOS (-) 2 KG



NA6063

- POLVO PARA CORREGIR EL PH DEL AGUA.
- VALORES NORMALES DE PH ENTRE 7.2 Y 7.6 PARA LOGRAR LA MÁXIMA EFICIENCIA DEL CLORO.
- DISMINUYE EL PH A VALORES NORMALES.
- GENERALMENTE NECESARIO PARA AGUAS DURAS.
- DOSIFICACIÓN: (CADA 40.000 L DE AGUA) 300 GRS.

NATABIO 1 LITRO



NA6061

- NUEVO TRATAMIENTO PROLONGADO PARA PISCINAS SIN CLORO!
- ALGUICIDA + ANTIMICROBIANO.
- LÍQUIDO COMPATIBLE CON CLORO ECOLÓGICO.
- RECOMENDAMOS EL USO DEL "TEST KIT NATABIO" PARA SU CORRECTA DOSIFICACIÓN.
- DURACIÓN DE 1 MES EN VERANO. DOSIFICACIÓN: (CADA 40.000 L DE AGUA) VERANO: 1 L MENSUAL. DURACIÓN DE 30 DÍAS.

FUNGICIDA 1 LITRO



NUEVO

NA6252

- CADA 50.000 LITROS: 1 LITRO. ANTE UNA FUERTE PRESENCIA DE HONGOS NEGROS, CEPILLAR LAS MANCHAS EN PAREDES Y PISO. FILTRAR EL AGUA, Y APLICAR LA MISMA DOSIS.

ALGUICIDA PILETAS DE LONA 500 CM³



NA6064

- ALGUICIDA PARA PILETAS DE LONA.
- COMBATE Y PREVIENE LA FORMACIÓN DE ALGAS, HONGOS Y BACTERIAS.
- NO REQUIERE CLORO
- NO PRODUCE ESPUMA.
- DOSIFICACIÓN: 30 CM3 (6 TAPITAS) CADA 1000 L DE AGUA, SEMANALES.

BOYA MULTIACCIÓN



NA6059

- TRATAMIENTO PROLONGADO DE 30 DÍAS DE DURACIÓN.
- LISTO PARA USAR.
- RECARGABLE.
- + ACCIÓN INMEDIATA.
- + CLORO ACTIVO
- + ALGUICIDA
- + CLARIFICADOR.

KIT PILETAS DE LONA



NA6055

- 1 PACK DE PASTILLAS MULTIACCIÓN X 250 GRS.
- 1 BOYA.
- PARA PILERAS DE 6000L TIENE UNA DURACIÓN APROXIMADA DE 30 DÍAS.



TENDER EXTENSIBLE DE ALUMINIO - MOR



INCLUYE TORNILLO Y TARUGO PARA SU COLOCACIÓN

NUEVO



80 CM **NA2051**
100 CM **NA2052**
120 CM **NA2053**

TENDER DE BalcÓN DE ALUMINIO - MOR

NUEVO

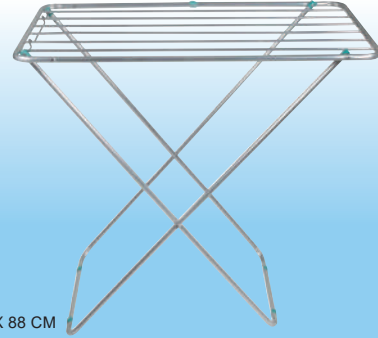

NA2350

PLEGABLE
MEDIDA: 82 X 56 X 88 CM

TENDER DE BalcÓN ALUMINIO CON ALAS SLIM - MOR

NA2303

- FACIL DE CERRAR Y LIVIANO
- MEJOR APROVECHAMIENTO DE ESPACIO IDEAL PARA LUGARES PEQUEÑOS
- 100% ALUMINIO
- MEDIDAS: 1,43M X 49CM. X 90CM.
- SOPORTA 13 KG. DE ROPA



TENDER DE BalcÓN DE ALUMINIO CON ALAS - MOR

NA2283

- NO SE OXIDA, IDEAL PARA LA COSTA
- FÁCIL DE CERRAR
- MÁS RESISTENCIA
- PIEZAS PLÁSTICAS QUE EVITAN ARAÑONES
- MEDIDAS: 1,53 X 56 X 94 CM



TENDER DE BalcÓN REFORZADO

TENDER CON ALAS REBATIBLE

TENDER CON ALAS REFORZADO



CON CINTAS ANTIDESLIZANTES
8 VARILLAS **NA2069**
9 VARILLAS **NA2070**

NA2071

- 8 VARILLAS
- CON CINTAS ANTIDESLIZANTES

NA2112

- MATERIAL DE ALTA RESISTENCIA
- 8 VARILLAS REFORZADAS
- ALAS DE 45 CM DE ANCHO X 50 CM DE LARGO
- ABIERTO: 1.90 M DE ANCHO X 0.95 M DE ALTO
- PIE FLEXIBLE PARA MEJOR PLIEGUE DEL MISMO

TABLA DE PLANCHAR

TABLA DE PLANCHAR

FUNDA ALUMINIZADA



NA2066
ANGOSTA

NA2067

ANCHA
MODELO DE LUJO

NA2099

PARA TABLA DE PLANCHAR

CHANGO DE ALUMINIO



RUEDA TREPADORA



W001

■ SUBE CORDONES, ESCALERAS Y CUALQUIER DESNIVEL SIN ESFUERZOS

PORTAVALIJAS REFORZADO



NA2060

BASE PARA HELADERA 2 PIEZAS



W115

CHANGO DE CAÑO ECONOMICO



NA2020

CON BOLSA INCLUIDA

CHANGO DE CAÑO REFORZADO



NA2021

REFORZADO
CON BOLSA INCLUIDA
2 RUEDAS GRANDES

CHANGO DE CAÑO CANADIENSE



NA2023

4 RUEDAS
CON BOLSA INCLUIDA

ESCALERAS

ESCALERA METÁLICA REFORZADA

2 PELDAÑOS	NA2032
3 PELDAÑOS	NA2033
4 PELDAÑOS	NA2034
5 PELDAÑOS	NA2035
6 PELDAÑOS	NA2036

ESCALERA DE ALUMINIO PELDAÑO REFORZADO C/ANTIDESLIZANTE

3 PELDAÑOS	NA2037
4 PELDAÑOS	NA2038
5 PELDAÑOS	NA2039
6 PELDAÑOS	NA2040
7 PELDAÑOS	NA2041
8 PELDAÑOS	NA2042



BANQUETA ESCALERA DE ALUMINIO PLEGABLE - 3 PELDAÑOS C/ ANTIDESLIZANTE

NA2097

PRACTICA Y LIVINA / NO OCUPA LUGAR
ALTURA: 63 CM / PLATAFORMA: 29 X 24 CM



REPOSERA



NUEVO

NA2308

2 POSICIONES
ESTRUCTURA DE ALUMINIO
CAÑO DE 3/4"
TELA COVERSOL



AQUA FILTER

CON KDF

CARTUCHO DE REPUESTO
PURIFICADOR DE AGUA
PARA CANILLA



X002

CARTUCHO DE REPUESTO

PURIFICADOR
DE AGUA
PARA MESA



X005

LORENZETTI



DUCHA LÍNEA PREMIUM

MAXI ULTRA



3 variantes
de temperatura
• 5500 W

NA7522

KIT DUCHA + BRAZO

MAXI ULTRA

NUEVO



3 variantes
de temperatura
• 5500 W

30PRO0034

RESISTENCIA ORIGINAL ULTRA

PARA DUCHA LORENZETTI
5500 W



NA7523

CALEFÓN BRAM-METAL 6 LTS

NA2336

G/E
ENCENDIDO A PILAS



NA2337

G/N
ENCENDIDO A PILAS

CALEFÓN ELÉCTRICO

NA7535

TANQUE PLÁSTICO
RESISTENTE
CAPACIDAD DE 20 LTS.
DILUVIO ECO BLACK



CALEFÓN ELÉCTRICO

NA7036

TANQUE PLÁSTICO
CAPACIDAD DE 20 LTS.



CALEFÓN ELÉCTRICO

NA7230

TANQUE PLÁSTICO
CAPACIDAD
DE 25 LTS.



CALEFÓN ELÉCTRICO

NA7035

TANQUE METÁLICO
CAPACIDAD DE 20 LTS.



**CALEFÓN ELÉCTRICO
DE ACERO INOXIDABLE**

NA7159

NORMALIZADO 20 LTS.
CONEXIÓN DE MÁXIMA SEGURIDAD
CON INTERRUPTOR POR FALTA DE
AGUA. RESISTENCIA BLINDADA DE 220
V - 50/60 HZ 1200 W IPX1
TABLERO CON TECLA INTERRUPTORA
BIPOLAR Y LUMINOSA



RESISTENCIA PARA CALEFÓN

ALUMINIO

NA7087

X 10 UNIDADES.



BRONCE

NA7086

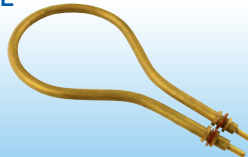

Dosi-3

▶ **PORTA VASO Y CEPILLOS PLÁSTICO**



NA5063
AUTOADHESIVA

▶ **JABONERA PLÁSTICA**



NA5057
AUTOADHESIVA

▶ **PORTA ROLLO PLÁSTICO DESMONTABLE**



NA5062
AUTOADHESIVA

▶ **TOALLERO PLÁSTICO**



NA5107
AUTOADHESIVO - MODELO ARO

▶ **TOALLERO PLÁSTICO**

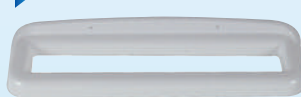

NA5108
AUTOADHESIVA - MODELO BARRAL

▶ **PORTA ROLLO PLÁSTICO**



NA5061
AUTOADHESIVA

▶ **GANCHOS CUELGA TAZA**



NA2048
SET X 6 PCS.
AUTOADHESIVOS

▶ **PERCHA PARA TOALLÓN**



NA2057
AUTOADHESIVA

▶ **PERCHAS**



NA2058
SET X 3 PCS.
AUTOADHESIVAS

▶ **PERCHAS GRANDES**



NA2059
SET X 2 PCS.
AUTOADHESIVAS

▶ **PERCHAS LARGAS**



NA2113
SET X 2 PCS.
AUTOADHESIVAS

▶ **TOPES CRISTAL**



NA2083
SET X 16 PCS.
REDONDOS
GRANDES
AUTOADHESIVOS

▶ **TOPES DE GOMA CHICOS**



NA2081
SET X 18 PCS.
AUTOADHESIVOS Y
ANTIDESLIZANTES

▶ **TOPES DE GOMA GRANDES**



NA2082
SET X 12 PCS.
AUTOADHESIVOS
ANTIDESLIZANTES

▶ **TOPES CRISTAL**



NA2116
SET X 16 PCS.
CUADRADOS
GRANDES
AUTOADHESIVOS

▶ **FIELTROS REDONDOS**



NA2080
SET X 8 PCS.
AUTOADHESIVOS

▶ **FIELTROS CUADRADOS**



NA2079
SET X 8 PCS.
AUTOADHESIVOS



TOPES AUTOADHESIVOS



SET X 2 PCS.
 RECTANGULARES **NA2077**
 REDONDOS **NA2078**

BURLETE AUTOADHESIVO



10 X 5 X 5 CM **NA8047**
 10 X 10 X 5 CM **NA8048**
 15 X 10 X 5 CM **NA8049**
 20 X 10 X 5 CM **NA8050**

ZÓCALO AUTOADHESIVO PARA PUERTAS

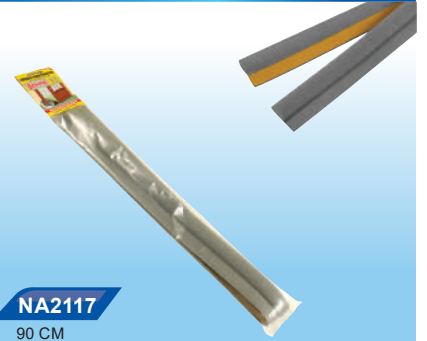

NA2117
 90 CM

ZOCALO AUTOADHESIVO



MARRÓN **NA2085**
 GRIS **NA2086**
 BLANCO **NA2087**
 NEGRO **NA20871**



ZÓCALO DE ALUMINIO



80 CM **NA2088**
 90 CM **NA2089**
 100 CM **NA2090**

TORNILLO DE BRONCE PARA INODORO O BIDET



SET X 100 PCS.
 PRECIO X UNIDAD
 TAMAÑOS: 22/60 - 22/70 - 22/80
 CON TARUGO, TUERCA Y
 ARANDELA DE REGALO

22/70 **NA5110**
 22/80 **NA5111**

SOPORTE PARA LAVATORIO

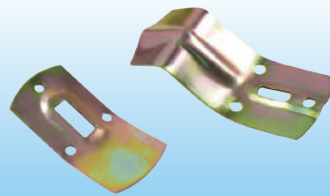

NA5089
 CORTO

NA5090
 LARGO

ARANDELA CON TORNILLO

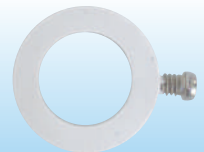

NA5122
 DE AJUSTE
 PARA TAPA "IDEAL"
 PRECIO X UNIDAD

CAÑO EXTENSIBLE PARA CORTINA DE BAÑO



NA5021
 BLANCO
 LARGO: 2 M

NA5020
 EN ALUMINIO
 LARGO: 2 M



CAÑO EXTENSIBLE PARA CORTINA DE BAÑO



NA5056
 DE LUJO
 LARGO: 2 M



TIRAS DE GOMA ANTIDESLIZANTES



NA5141

PARA BAÑERA
8 TIRAS - 3 X 35 CM.

TIRAS DE GOMA ANTIDESLIZANTES



NA5142

PARA ESCALERA
10 TIRAS - 3 X 50 CM.

BOTÓN PLÁSTICO



NA5008

PARA DEPÓSITO "FRANKLIN"

TAPA PLÁSTICA



MODELOS:

IDEAL **NA5096**
FRANKLIN **NA5097**

TAPA INTERIOR CON BOTÓN "IDEAL"



NA5095

TAPA INTERIOR CON BOTÓN "FRANKLIN"



NA5094

PALITO PORTA ROLLO

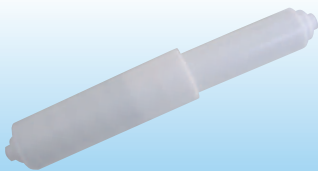

NA5060

PLÁSTICO

DESBORDE UNIVERSAL ECONÓMICO



NADS32

DESBORDE UNIVERSAL CON CARGA



NADS01

DESBORDE PARA DEPÓSITO TIPO PALANQUITA



NADS13

DESBORDE PARA MOCHILA CON GANCHO



NADS04

DESBORDE PARA MOCHILA CON TIRADOR DORICA



NADS02



ASIENTO PARA INODORO - MODELO FLORENCIA

SOPLADO



NUEVO

NA5257

INYECTADO



NUEVO

NA5258

ASIENTO PARA INODORO UNIVERSAL OPTIMO MDF



NA5124

- BLANCO
- MDF DE ALTA DENSIDAD
- HERRAJES PLÁSTICOS

ASIENTO PARA INODORO UNIVERSAL PREMIUM



INYECTADO REFORZADO

NA5194

- SISTEMA DE BISAGRAS CON CORREDERAS AJUSTABLES Y ADAPTABLES
- FACIL LIMPIEZA E INSTALACIÓN

MOCHILA PARA INODORO



NA5143

8 LITROS DE COLGAR A CADENA



NA5144

11 LITROS DE COLGAR A BOTÓN



NA5147

11 LITROS MOCHILA CON TECLA SUPERIOR



NA5148

12 LITROS MOCHILA CON TECLA LATERAL CISTERNA FLAPER

REPUESTO PARA MOCHILA



NA5065

CON FLAPPER T/CAPEA

REPUESTO PARA MOCHILA



NA5066

DESCARGA DE APOYO C/ VASO T/ FERRUM

VÁLVULA DE ADMISIÓN REGULABLE



ROSCA PLÁSTICA

3/8" NA5118

1/2" NA5119

VÁLVULA DE ADMISIÓN DE CARGA



NUEVO

1/2" X 23 CM NAVL20

1/2" X 29 CM NAVL21

3/8" X 29 CM NAVL17

1/2" X 33 CM NAVL22

BOYA FLOTANTE PARA DEPÓSITO



NUEVO

NA5053

BOYA FLOTANTE PARA TANQUE



NUEVO

NA5268

CONJUNTO AQUA KIT APOYO

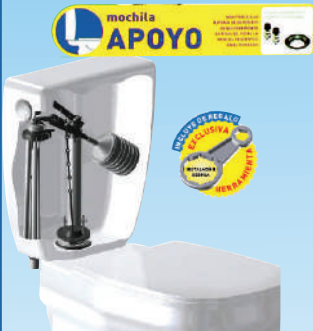

COLOR CROMADO
LATERAL **NA5175**
SUPERIOR **NA5176**
FRONTAL **NA5177**

CONJUNTO AQUA KIT A CODO



COLOR CROMADO
LATERAL **NA5178**
SUPERIOR **NA5179**
FRONTAL **NA5180**

DEPÓSITO MOCHILA ECO FLUSH



NA5210

- CAPACIDAD: 12 LTS.
- LISTOS PARA INSTALAR
- INCLUYE MECANISMOS
- ACCESORIOS DE INSTALACIÓN INCLUIDOS
- ECONOMIZA HASTA UN 30% DE AGUA

VÁLVULA CON FLOTANTE



NA5236

- PARA TANQUES
- CONEXIÓN DE: 1/2" Y 3/4"

CONEXIÓN FUELLE



NA5182

EXTENSIBLE 2"

VÁLVULA DE ADMISIÓN BRAZO REGULABLE



NA5167

- DIÁMETRO DE ROSCA: 1/2"
- ALTO LARGO: 12"

VÁLVULA DE ADMISIÓN LATERAL HEMBRA



NA5170

- DIÁMETRO DE ROSCA: 1/2"
- ALTO LARGO: 8"-14"

VÁLVULA DE ADMISIÓN ECO



NA5168

- DIÁMETRO DE ROSCA: 1/2"
- ALTO LARGO: 10"

VÁLVULA DE ADMISIÓN INTEGRAL AQUA VIAR



NA5169

- DIÁMETRO DE ROSCA: 1/2"
- ALTURA LARGO 8" - 14"

VÁLVULA DE DESCARGA INTERRUPTIBLE AQUA STOP



NA5173

- DIÁMETRO DE ROSCA: 2"
- DESCARGA DE 3 A 6 L REGULABLE

VÁLVULA DE DESCARGA C/BOTÓN DOBLE ACCIONAMIENTO AQUA DUO



NA5174

- DIÁMETRO DE ROSCA: 2"

CANILLA 1/2" PARA LAVATORIO



NA5203

LAVATORIO PLÁSTICO CHICO



Con accesorios para fijación

NA5192

- MATERIA PRIMA 100% VIRGEN
- FABRICADO EN POLIPROPILENO
- ALTA DENSIDAD
- RESISTENTE
- FÁCIL INSTALACIÓN



VÁLVULA DE DESCARGA ACCIONAMIENTO LATERAL Y FRONTAL



NA5171

- DIÁMETRO DE ROSCA: 2"
- ALTO LARGO: 225-325MM

VÁLVULA DE DESCARGA ACCIONAMIENTO SUPERIOR



NA5172

- DIÁMETRO DE ROSCA: 2"
- ALTO LARGO: 240 MM

CONEXIÓN JUNTA APOYO



NA5185

86 MM



NA5186

105 MM

CONEXIÓN DESPLAZADOR INODORO



NA5183

35 MM
Ø 100 MM



NA5184

55 MM
Ø 100 MM

REPUESTO FLAPPER ECO FLUSH



NA5181

PALANCA DE ACCIONAMIENTO



NA5187

CROMADA 3/8"

BOTÓN ACCIONAMIENTO LATERAL



NA5188

CROMADO 38 MM

BOTÓN ACCIONAMIENTO SUPERIOR



NA5189

CROMADO 38 MM

BOTÓN DOBLE ACCIÓN SUPERIOR



NA5239

CROMADO 38 MM

VÁLVULA PARA TANQUE DE BRONCE



1/2" **NA5196**
3/4" **NA5197**

VÁLVULA PARA TANQUE DE BRONCE



- ALTA PRESIÓN
- VARILLA LARGA

1/2" **NA5198**
3/4" **NA5199**

CONTROL DE NIVEL HERMÉTICO



NA5190

- AUTOMÁTICO PARA TANQUE DE AGUA

VÁLVULA PARA DEPÓSITO 1/2"



NUEVO

NA5250

VÁLVULA PARA TANQUE DE AGUA 1/2"



NUEVO

NA5251

VÁLVULA PARA TANQUE DE AGUA 3/4"



NUEVO

NA5255

REJILLA DE VENTILACIÓN



EPOXI METÁLICA ESMALTADA

15X15 CM **NA8198**
15X30 CM **NA8199**

REJILLA DE VENTILACIÓN



15X15 CM APROB. AL 100% **NA8346**
15X30 CM APROB. AL 200% **NA8340**

REJILLA DE VENTILACIÓN



20X20 CM APROB. AL 100% **NA8200**
20X20 CM APROB. AL 200% **NA8458**

REJILLA DE VENTILACIÓN PARA VIDRIO



NA8480
APROBADA INST. GAS
15 X 15 CM

REJILLAS DE FUNDICIÓN



15 X 15 CM **NA8459**
20 X 20 CM **NA8460**
25 X 25 CM **NA8461**
30 X 30 CM **NA8462**

REJILLA DE ACERO INOXIDABLE

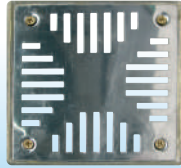

10 X 10 CM **NA8194**
12 X 12 CM **NA8195**
15 X 15 CM **NA8196**
20 X 20 CM **NA8197**

REJILLA AUTOADHESIVA PARA REJILLA DE PISO

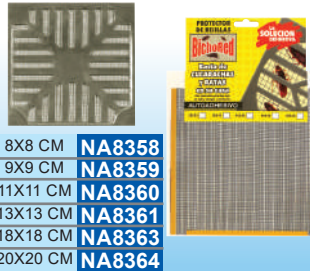

8X8 CM **NA8358**
9X9 CM **NA8359**
11X11 CM **NA8360**
13X13 CM **NA8361**
18X18 CM **NA8363**
20X20 CM **NA8364**

REJILLA AUTOADHESIVA PARA REJILLA DE PARED



15X15 CM **NA8362**
15X30 CM **NA8465**

REJILLA PVC CON MARCO



NA8558
20 X 20 CM

TAPA CIEGA DE ACERO INOXIDABLE

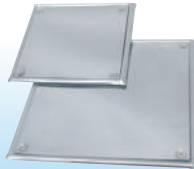

10 X 10 CM **NA8537**
12 X 12 CM **NA8538**
15 X 15 CM **NA8256**
20 X 20 CM **NA8257**

RECEPTÁCULO A CODO



NA8536
8 X 8 CM

FLEXIBLE PARA GAS



1/2"
30 CM **NA5040**
40 CM **NA5041**
50 CM **NA5042**
60 CM **NA5043**
80 CM **NA5044**
100 CM **NA5045**

FLEXIBLE PARA AGUA



CON CONECTORES METÁLICOS - 1/2"
20 CM **NA5037**
30 CM **NA5038**
40 CM **NA5039**
50 CM **NA5127**



PVC GRIS - 1/2"
20 CM **NA5049**
30 CM **NA5050**
40 CM **NA5051**
50 CM **NA5052**
60 CM **NA5195**



PARA MONOCOMANDO X 2 F/C
35 CM **NA5232**
40 CM **NA5233**
50 CM **NA5234**



MALLADO ACERO
25 CM **NA5244**
30 CM **NA5245**
35 CM **NA5246**
40 CM **NA5247**
50 CM **NA5248**

FILTRO REJILLA Y TAPONES

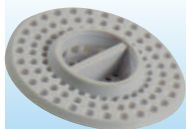

NA8365
PVC

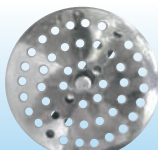

NA8193
ACERO INOXIDABLE



NA5140
UNIVERSAL - PVC

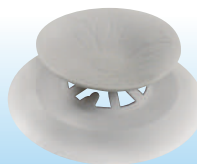

NA5139
RETRACTIL- PVC



NA5093
DE GOMA UNIVERSAL



SOPAPA CON REJILLA DE ACERO INOXIDABLE
1 1/2" **NA5091**
2" **NA5092**



SOPAPA PCV A CODO 2"



NA5267

SOPAPA VENTOSA NEGRA



NA5087
ESTANDAR

NA5088
GIGANTE

CINTA DESTAPA CAÑERIAS

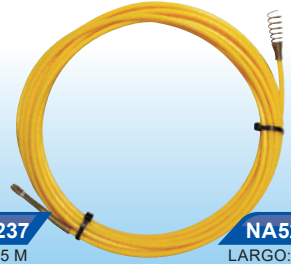

NA5237
LARGO: 5 M

NA5238
LARGO: 10 M

CINTA DESTAPA CAÑERIAS



M250
LARGO 4M

CINTA DESTAPA CAÑERIAS



NA5026
5M

NA5027
10M

CON TERMINAL DE BRONCE Y TIRABUZÓN
LARGO: 5 M Y 10 M

FLEJE DESTAPA CAÑERIAS



NA5035

CONEXIONES DE BRONCE.
PRECIO POR TRAMO DE 1.50 M

SIFONES



NA5070
SIMPLE



NA5071
DOBLE



NA5072
DOBLE EXTRACHATO

ACCESORIOS PARA FLEJE



NA5004
MANIJA



NA5002
TIRABUZÓN

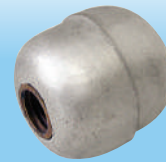

NA5001
BOCHA

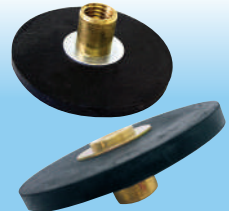

NA5003
SOPAPA

FUELLE REPUESTO SIFON



NA5160

FUELLE CONECTOR PLÁSTICO



NA2092

MULTIMEDIDA
EXTENSIBLE HASTA 82 CM

ARO BASE PARA INODORO



NA5158

FUELLE PARA INODORO



NA5054



NA5128
LARGO



NA5157
MOCHILA REGULABLE



NA5159
DESPLAZADO

LLAVE EXCLUSA CROMADA



1/2" **M311**
3/4" **M312**

CANILLA CROMADA



CON MANGA
1/2" **M300**
3/4" **M301**

CANILLA PVC 1/2"



NA8416
GRIS
GRANDE

CANILLA PARA LAVARROPAS - CROMADA



NA5019

CHUPETE DE GOMA



PARA CANILLA Y MANGUERA
1/2" **NA5024**
3/4" **NA5025**

VÁLVULAS PARA CANILLAS



PACK X 100 PCS.
CUERO 1/2" **NA5112**
GOMA 1/2" **NA5113**

CORREA ALLADIO PARA LAVARROPA MULTI V - CORTA



CORTA **NA7220**
LARGA **NA7221**

BRAZO CROMADO



NA5011
PARA LLUVIA

DUCHA CROMADA



NA5033
CHICA

NA5034
GRANDE

DUCHADOR MANUAL CROMADO



NA5032
1 FUNCIÓN CON MANGUERA METÁLICA 1.5 M

LLUVIA PLÁSTICA CROMADA



NA5059

LLUVIA PARA BIDET



1/2" **NA5263**
3/8" **NA5264**

PILETA PARA LAVADERO



NA5260
BLANCA



NA5262
GRIS



NA5261
NEGRA

INYECTADAS EN POLIPROPILENO.
CON FREGADERO Y JABONERA.

CAPACIDAD 35 LTS.
ACCESORIOS PARA FIJACIÓN INCLUIDOS.

MEDIDAS: 50 X 60 X 37 CM.



TERMO ACERO INOXIDABLE KOVEA



• TAPÓN PARA TERMO DE 1 LT KOVEA



NA2285

TAPÓN DE SEGURIDAD

Apertura y cierre automático por botón central

- CALIDAD SUPERIOR.
- APERTURA DE UN TOQUE.
- PICO DE FÁCIL LIMPIEZA.
- MANTIENE LA TEMP. POR 24 HS.

LÍNEA BLACK

0.5 LT NA22681

0.75 LT NA22682

1 LT NA2268



TERMO ACERO INOXIDABLE MOR 1 L



TAPÓN DE SEGURIDAD

Apertura y cierre automático con pico vertedor

NA2299

- CALIDAD SUPERIOR
- APERTURA A ROSCA
- PICO DE FÁCIL LIMPIEZA
- MANTIENE LA TEMPERATURA POR 10 HS



CANTIMPLORA SOPRANO 1 L



NA2362

BIDÓN TÉRMICO 2.5 LTS



NA2011

BIDÓN TÉRMICO 5 LTS



NA2239

CONSERVADORA SOPRANO 28 LTS



NA2360

CONSERVADORA SOPRANO 32 LTS



NA2272

COMBO CONSERVADORAS SOPRANO



NA2361

CONSERVADORA DE 5 LTS + 12 LTS + 32 LTS

CONSERVADORA PLEGABLE 38 LTS

NO NECESITA HIELO!

PLEGABLE!

SUPER LIVIANA!

MUY RESISTENTE!



ARTIC ICE



TAMBIÉN MANTIENE LA COMIDA CALIENTE!

MÁS CAPACIDAD DE GUARDADO!
600 x 257 x 406 MM

38 LTS

257 MM

105 MM



FÁCIL Y PRÁCTICO PARA ARMAR!

MC-060

MANTIENE FRÍO / CALOR

ANAFE DE CAMPING



NA2001

CON CHISPERO
Y VALIJA PLÁSTICA

ANAFE DE COCINA



NA2002

1 HORNALLA - ENLOZADO
CON ROBINETE

ANAFE DE COCINA

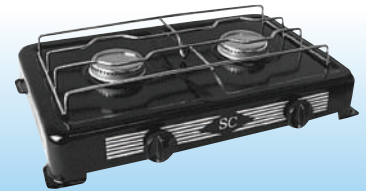

NA2005

2 HORNALLAS
ENLOZADO C/ROBINETE

ANAFE DE COCINA DE LUJO



NA2096

2 HORNALLAS - ENLOZADO
QUEMADORES DE ALUMINIO

ANAFE DE COCINA DE LUJO



NA2317

4 HORNALLAS
ENLOZADO
QUEMADORES DE ALUMINIO

ANAFE DE COCINA CON HORNO



NA2006

2 HORNALLAS
QUEMADORES DE ALUMINIO

ANAFE DE COCINA CON HORNO



NA2008

4 HORNALLAS
CON HORNO
QUEMADORES DE ALUMINIO

CALENTADOR A GAS



NA2013

ENLOZADO
PARA GARRAFA
2/3 KG.

CALENTADOR A GAS



NA2014

PARA GARRAFA DE 10 KG

CALENTADOR ELÉCTRICO



NA2103

800 W



RESISTENCIA ESPIRAL



NA7246

800W

REGULADOR DE GAS



NA8319

PARA GARRAFA



CON MANGUERA

1 M **NA8318**

1.5M **NA8415**

PARA GARRAFA

CALISUAR PARA GAS CALIBRADO



NA8643

X 7 UNIDADES
0.5 A 2 MM

NA8332

X 10 UNIDADES
MEDIDAS: 0.17 - 0.35 - 0.5 - 0.8 -
1 - 1.25 1.5 - 1.8 - 2 - 2.25 MM

CAMISA PARA FAROL



R760

DE 500 BUJÍAS

PRECIO UNITARIO - SET X 12 PCS.

TERMOCUPLA



VÁLVULA DE ALIVIO 3/4"



NA7433

CON GRIFO

RESISTENCIA TERMOTANQUE ABRASOL

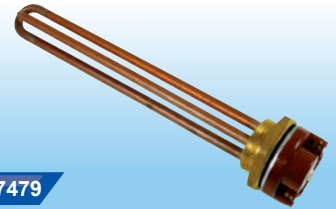

NA7479

1500 W

PIEZO ELÉCTRICO VOLCAN STANDAR



NA7219

ESTRELLITA CON ROSCA

UNIDAD MAGNÉTICA STANDAR



NA7371

CON ROSCA

8X1 250MM **NA7243**

8X1 300MM **NA7222**

8X1 400MM **NA7223**

8X1 500MM **NA7224**

8X1 600 MM **NA7244**

8X1 1000 MM **NA7245**

8X1 1200MM **NA7228**

CALOVENTOR ELÉCTRICO INDELPLAS



NA8600

- 1800 W - 220 V
- 1 NIVEL DE VENTILACIÓN
- 2 NIVELES DE TEMPERATURA
- TERMOSTATO AUTOMÁTICO CON CORTE DE SEGURIDAD

CALOVENTOR CALOVENTOR RUBI C1111- MAGICLICK



NA7534

- 2000 W - 220 V
- TERMOSTATO AUTOMÁTICO PARA REDUCIR EL CONSUMO

PANTALLA DIRECTA CIRCULAR



PARA GAS ENVASADO

1500 CALORIAS **NA2052**

3000 CALORIAS **NA2125**

PANTALLA DIRECTA



NA2051

PARA GAS ENVASADO

PANTALLA PARA GAS NATURAL

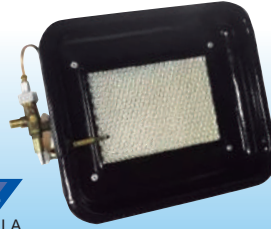

NA2054

CON VÁLVULA
1500 CALORIAS

**PANTALLA DOBLE
PARA GAS NATURAL**



NA2056

CON VÁLVULA
1500 - 3000 CALORIAS

**ESTUFA
HALOGENA**



NA7155

1200 W - 220 V - 50 HZ
AMPLIA MANIJA P/ TRANSPORTE
TRES NIVELES DE POTENCIA
OSCILANTE
BASE PLÁSTICA REDONDA
SEGURIDAD ANTI-VUELCO

**ESTUFA DE CUARZO
MAGICLICK**



NA7045

POTENCIA 1200 W
TECLA DE CORTE AUTOMÁTICO
2 TEMPERATURAS

**ESTUFA DE CUARZO
DELUXE**



30PRO0030

POTENCIA 1200 W
2 TEMPERATURAS
CAJA X 10 UNIDADES

NA7046

CAJA INDIVIDUAL
POTENCIA 1200 W
CON TECLA DE CORTE AUTOMÁTICO
2 TEMPERATURAS

30PRO0040

CON TECLA DE CORTE
AUTOMÁTICO
2 TEMPERATURAS
CAJA X 10 UNIDADES

CALEFACTOR GARRAFERO



NA2126

- ENCENDIDO ELECTRÓNICO.
- PILOTO ANALIZADOR DE AMBIENTE
- SISTEMA DE SEGURIDAD ANTIVUELCO.
- PARA USO CON GARRAFA DE 10 KG.
- VÁLVULA DE SEGURIDAD.
- PROVISTO DE RUEDAS PARA SU TRASLADO.

CALENTADOR DE PATIO



DAEWOO
POWER PRODUCTS



DACZGB-A

- POTENCIA: 10.320 KCAL/H
- TIPO DE GAS: PROPANO, BUTANO Y MEZCLAS (LPG)
- INTERRUPTOR: ANTI-INCLINACIÓN
- DISPOSITIVO: APAGADO AUTOMÁTICO DE LLAMA INCLUIDO.
- TAMAÑO DE PRODUCTO: DIÁM. 810 MM X 2210 MM (H)

CALENTADOR DE PATIO



DAEWOO
POWER PRODUCTS



DACZGB-I

- POTENCIA: 11.178 KCAL/H
- UTILIZA ÚNICAMENTE: GAS BUTANO - ALTERNATIVA: GAS PROPANO
- CONSUMO: 945 G/H (BUTANO) - CONSUMO: 928 G/H (PROPANO)
- MATERIAL: ACERO INOXIDABLE
- INCLUYE: REFLECTOR, ENCENDIDO ELECTRÓNICO Y RUEDAS.



▶ VENTILADOR TURBO INDELPLAS

- SILENCIOSO
- BAJO CONSUMO
- COMPACTO
- 5 ASPAS

- PERILLA REGULADORA DE ÁNGULO BOTONERA
- BASE PARA FIJAR A PISO O PARED
- BOTONERA DE 3 VELOCIDADES

12"	35 W	NA7501
16"	60 W	NA7395
20"	75 W	NA7499



▶ VENTILADOR TURBO 20"

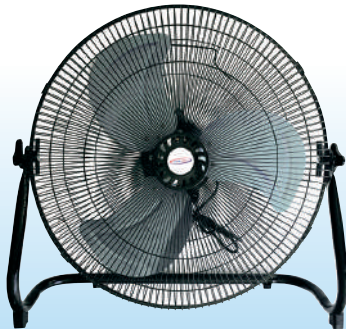

- REJILLA METÁLICA
- POTENCIA 100W
- 3 ASPAS METÁLICAS
- 3 VELOCIDADES
- BASE PARA FIJAR A PISO

TR20

▶ VENTILADOR DE PIE INDELPLAS 20"



- POTENCIA 90W
- 5 ASPAS
- 3 VELOCIDADES
- CABEZAL OSCILANTE CON INCLINACIÓN
- REGULACIÓN DE ALTURA

NA7525

▶ VENTILADOR 3 EN 1 - 18"



- POTENCIA 70W
- 5 ASPAS METÁLICAS
- 3 VELOCIDADES
- REGULABLE EN ALTURA
- BASE PARA FIJAR A PISO

FY-18A



CABO DE MADERA



CON ROSCA
1.20 M **NA2123** P/ CEPILLO ANDEN
1.50 M **NA2124** P/ CEPILLO BARRENDERO

CEPILLO BARRENDERO



NA2118

CEPILLO ANDEN CERDA PLÁSTICA



6 HILERAS DE CERDAS
60 CM **NA2119**
80 CM **NA2120**

CEPILLO ANDEN CERDA NATURAL



6 HILERAS DE CERDAS
60 CM **NA2121**
80 CM **NA2122**

NÚMEROS ADHESIVOS



W200
DORADOS
PLÁSTICOS

PICO DE BRONCE



NA3004
PARA INFLADOR PELOTA

PORTA CD



DIS086
CAPACIDAD
12 CD'S

PICADORA DE CARNE METÁLICA



U300
METÁLICA. N° 8
CON PRENSA
PARA MESA

U310
METÁLICA. N° 12
DE MESA

LLAVE COMBINADA SATINADA



MILIMÉTRICAS	
8mm	DIS015
9mm	DIS016
12mm	DIS017
15mm	DIS018
16mm	DIS019
18mm	DIS020

EN PULGADAS	
1/4"	DIS007
5/8"	DIS009
3/4"	DIS010
7/8"	DIS011
1"	DIS012
1 1/4"	DIS013

CUCHILLOS DE COCINA



DIS097



DIS054



DIS060



DIS058

DESTORNILLADOR TORX



PUNTA IMANTADA

T15 **B942**
T27 **B945**
T30 **B946**
T40 **B947**

ALIANZA COMERCIAL CON

HIDROLAVADORA 1200W



DAX1130

- POTENCIA 1.200 W
- PRESIÓN MÁX: 105 BAR / PRESIÓN NOMINAL: 70 BAR
- TEMPERATURA MÁXIMA DEL AGUA 50 °C
- INCLUYE PISTOLA, LANZA, EXTENSOR DE DE LANZA Y BOQUILLA LANZA ESPUMA.

HIDROLAVADORA 1600W



DAX65-100

- POTENCIA: 1.600 W
- PRESIÓN MÁXIMA: 105 BAR
- PRESIÓN NOMINAL: 53 BAR
- CAUDAL MÁX: 426 L/H / CAUDAL NOMINAL: 330 L/H
- TEMPERATURA MÁXIMA DEL AGUA: 50 °C
- CONEXIÓN CABLE: 5 M
- INCLUYE: PISTOLA, LANZA, BOQUILLA AJUSTABLE DE 0° A 60°, MANGUERA DE ALTA PRESIÓN DE 5 M, BOTELLA DE DETERGENTE, FILTRO DE ENTRADA, LIMPIADOR DE BOQUILLA Y ESPONJA.

HIDROLAVADORA 2000W



DAX21-150

- POTENCIA 2.000 W
- PRESIÓN MÁXIMA 140 BAR
- CAUDAL NOMINAL 360 L/H / CAUDAL MÁX. 420 L/H
- PRESIÓN MÁXIMA DE ENTRADA DE AGUA 12 BAR
- INCLUYE: PISTOLA, EXTENSOR DE LANZA, MANGUERA 5 M, CONECTOR RÁPIDO, DISPENSER DE DETERGENTE.

FRESADORA 1250W



DAER1250

- POTENCIA 1250 W
- DIÁMETRO DEL COLLAR 6-8 MM
- DIÁMETRO DE LA PINZA 8 MM
- INCLUYE ACCESORIOS
- VELOC. SIN CARGA 11500-34000 RPM

BOMBA PRESURIZADORA 100W



DAEPRESS100

- POTENCIA 100 W / PRESIÓN MÁXIMA 10 BAR
- ALTURA MÁXIMA 9 M / CAUDAL MÁXIMO 1.5 M³/H
- DIÁMETRO DE SUCCIÓN 3/4 "
- FASE SIMPLE
- INSULACIÓN CLASE F

BOMBA PRESURIZADORA 260W



DAEPRESS260

- POTENCIA 260 W / PRESIÓN MÁXIMA 10 BAR
- ALTURA MÁXIMA 12 M / CAUDAL MÁXIMO 3 M³/H
- DIÁMETRO DE SUCCIÓN 1 " «
- FASE SIMPLE
- INSULACIÓN CLASE F

TERMOFUSORA



DAPW63CP-8

- POTENCIA 800 W
- TOMAS DE SOLDADURA: 20, 25, 32 MM
- MÁS TOMAS 40, 50, 63 MM
- INCLUYE: 6 BOQUILLAS, LLAVE L,
- DESTORNILLADOR Y MALETÍN METÁLICO.

SOPLADORA ELÉCTRICA 600W



DAEB600

- POTENCIA 600 HP - 370W
- CAUDAL: 3M³/MIN
- VOLTAJE / FRECUENCIA: 220V-HZ
- VELOCIDAD SIN CARGA: 0-1400 RPM.

SOPLADORA ASPIRADORA ELÉCTRICA 2500W



DAEB2500

- POTENCIA 2500W / PESO: 2.8 KG.
- SUCCIONA, SOPLA Y TRITURA.
- VELOCIDAD DE SOPLADO: 270K/H
- CAPACIDAD DE BOLSA: 45 L.



DESMALZADORA 52 CC 1,46KW



D520ECO

- CILINDRADA: 52CC. / TIEMPOS DEL MOTOR: 2. / CAPACIDAD DEL TANQUE DE COMBUSTIBLE: 1200 ML. / CAPACIDAD DEL DE NAFTA: 1.2 L. / SISTEMA DE CORTE: DISCO DE 3 PUNTAS, TANZA. SISTEMA DE ARRANQUE MANUAL.
- CON PROTECTOR DE SEGURIDAD

MOTOSIERRA A GASOLINA 2.7HP



DAM5220

- MOTOR MONOCILINDRICO, 2 TIEMPOS, REFRIGERACION POR AIRE. POTENCIA 2.1 KW, CILINDRADA 52 CC, LONG. DE ESPADA 20", RALENTI 3000 ± 200 RPM, CAP. TANQUE ACEITE 260 ML, CAP. TANQUE COMBUSTIBLE 550 ML
- INCLUYE ESPADA, CADENA Y SU PROTECTOR, BOTELLA 600 ML
- CON KIT DE HERRAMIENTAS.

ELECTROSIERRA 2200W



DCS2216E

- POTENCIA 2.200 W
- VOLTAJE/FREC. 220 V 50 HZ
- LONG. DE ESPADA 16"/405 MM
- VELOCIDAD DE CORTE 13 M/S
- VELOCIDAD SIN CARGA 7000 RPM
- CAP. DEL TANQUE DE ACEITE 350 ML
- INCLUYE PROTECTOR DE ESPADA
- VELOCIDAD SIN CARGA 7000 RPM.

KIT DE MECHAS PARA PARED - 8 PCS



DWKIT8M

- 8 UNIDADES.
- TAMAÑOS 10/8/8/6/6/5/4/3 MM.

KIT DE MECHAS PARA MADERA - 8 PCS



DWKIT8W

- 8 UNIDADES.
- TAMAÑOS 10/8/8/6/6/5/4/3 MM.

KIT DE MECHAS PARA METAL - 10 PCS



DWKIT10

- 10 UNIDADES.
- TAMAÑOS 10/9/8/7/6/5/4/3/2/1 MM
- DIN 338 / HSS 4341

KIT DE MECHAS PARA METAL - 13 PCS



DWKIT13

- 13 UNIDADES.
- TAMAÑOS 6.5/6/5.5/5/4.8/4.5/4/3.5/3.2/3/2.5/2/1.5 MM.
- DIN 338 / HSS 4341

KIT DE MECHAS PARA TALADROS DE TORSION PARA METAL - 19 PCS



DWKIT19

- 19 UNIDADES.
- DIN 338
- TAMAÑOS: 10/9.5/9/8.5/8/7.5/7/6.5/6/5.5/5/4.5/4/3.5/3/2.5/2/1.5/1 MM

KIT DE MECHAS Y PUNTAS 50 PCS

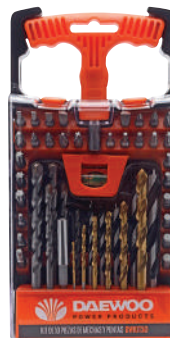

DWKIT50

- 1 DESTORNILLADOR TIPO T, 1 NIVELADOR (BURBUJA), PUNTAS: CUADRADOS X 3, PZ X 4, PH X 4, HEXAG. X 6, TORX X 8, PLANAS X 5. MECHAS: P/ MADERA X 5 (4-5-6-8-10 MM), P/ METAL X 6 (2-3-4-5-6-8 MM), P/ PARED X 6 (1X5-2X6-2X8-1X10 MM), 1 ADAPTADOR MAGNÉTICO.

KIT DE MECHAS Y PUNTAS 81 PCS



DWKIT81

- MECHAS HELICOIDALES CON REVESTIMIENTO DE TITANIO X 10.
- MECHA P/ MADERA X 5, MECHA P/ PARED X 5,
- 1 AVELLANADOR, PUNTAS DE 25 MM X 40, PUNTAS PARA DESTORNILLADOR X 10, 1 ADAPTADOR, ADAPTADOR DE LLAVE TUBO X 9.